

ELECTRICAL SERVICE REQUIREMENTS

FOR
RESIDENTIAL CUSTOMERS AND
TEMPORARY CONSTRUCTION POWER



KETCHIKAN PUBLIC UTILITIES, ELECTRIC DIVISION
1065 Fair Street
Ketchikan, Alaska 99901
(907) 225-5505

JANUARY 2019

PAGE INTENTIONALLY LEFT BLANK

KPU ELECTRIC SERVICE REQUIREMENTS - RESIDENTIAL

TABLE OF CONTENTS

To Our Customers:

KPU assembled this booklet to assist its Customers and their architects, engineers, and electrical contractors in planning for and obtaining electrical service. The information presented here is intended to supplement the requirements of the National Electrical Safety Code (NESC), National Electric Code (NEC), and all other applicable Federal, State, or Municipal codes, regulations, laws, and ordinances.

KPU strives to provide safe and reliable power and to serve its Customers promptly and satisfactorily in completing service connections.

KPU Electric Division Manager

INTRODUCTION.....	1
UPGRADES.....	2
GETTING STARTED.....	2
Electrical Service Request – Residential Form.....	5
Residential Service Checklist	7
SECTION 1 – GENERAL SERVICE REQUIREMENTS	9
1.1 Service Entrance Equipment Location and Access	9
1.2 Service Entrance Equipment.....	9
Figure 1 – Meter Panel Clearances.....	11
SECTION 2 – UNDERGROUND SERVICE REQUIREMENTS.....	12
2.1 Secondary Trench	12
2.2 Secondary Conduit Systems and Conductor.....	13
Figure 2 – Underground Service – Type A.....	14
Figure 3 – Underground Service – Type B.....	14
Figure 4 – Underground Service – Type C.....	15
Figure 5 – Underground Service – Type D.....	15
Figure 6 – Surface Mount Underground Meter Panel	16
Figure 7 – Pedestal Underground Meter Panel.....	16
Figure 8 – Underground Secondary Trench, Typical	17
2.3 Primary Line Extension.....	18
2.4 Primary Trench.....	18
2.5 Primary Conduit Systems and Conductor	18

KPU ELECTRIC SERVICE REQUIREMENTS - RESIDENTIAL

TABLE OF CONTENTS

2.6 Vegetation and Obstructions	19
2.7 Landscaping	19
2.8 Padmounted Transformer	19
Figure 9 – Underground Primary Trench, Typical	20
SECTION 3 – OVERHEAD SERVICE REQUIREMENTS	21
3.1 Weatherhead, Mast, and Drip Loop	21
3.2 Vegetation and Obstructions	22
3.3 Vertical Clearances – KPU-Owned Secondary Conductors (Less than 750V)	22
3.4 Maximum Span Lengths.....	22
3.5 Meter Poles and Posts	22
Figure 10 – Overhead Service – Type E	23
Figure 11 – Overhead Service – Type F	23
Figure 12 – Overhead Service – Optional Lift Pole.....	23
Figure 13 – Overhead Service – Type G.....	24
Figure 14 – Overhead Service – Type H.....	24
Figure 15 – Minimum Overhead Clearances – Roadways and Walkways.....	25
Figure 16 – Minimum Overhead Clearances – Private Property Buildings and Structures.....	25
Figure 17 – Meter Pole/Post Specification – Type G, Overhead to Underground	26
Figure 18 – Meter Pole/Post Specification – Type H, Overhead to Overhead	27
SECTION 4 – GROUNDING AND BONDING REQUIREMENTS.....	28
4.1 Grounding Electrode Systems.....	28
4.2 Grounding Electrode Conductor	28
4.3 Bonding and Grounding	29
SECTION 5 – SERVICE ENTRANCE EQUIPMENT REQUIREMENTS.....	30
5.1 Self-Contained Meter Socket (Meter Panel) – 100 through 400 Amps.....	30
5.2 CT Service Entrance Equipment – 401 through 800 Amps	30
5.3 Main Service Disconnect.....	31
5.4 Wire Terminations and Connections	31
Figure 19 – Residential Combination Meter Panel – 225 Amps.....	32
Figure 20 – Meter Socket Connection Diagram	33
SECTION 6 – SPECIAL REQUIREMENTS.....	34

KPU ELECTRIC SERVICE REQUIREMENTS - RESIDENTIAL
TABLE OF CONTENTS

6.1 Multi-Meter Residential Services.....	34
6.2 Primary Metered Residential Services.....	35
Figure 21 – Combination Residential Multi-Meter Panels	36
Figure 22 – Wall Mounted Pull Box.....	37
6.3 Standby Generators	38
Figure 23 – Standby Generator – Alternative 1.....	39
Figure 24 – Standby Generator – Alternative 2.....	40
6.4 Temporary Services.....	41
Figure 25 – Meter Pole/Post Specification – Overhead Temporary /Construction	42
APPENDIX A – Forms and Checklist.....	A

PAGE INTENTIONALLY LEFT BLANK

KPU ELECTRIC SERVICE REQUIREMENTS – RESIDENTIAL

INTRODUCTION

Ketchikan Public Utilities¹ (KPU) offers both underground and overhead electrical services, depending on customer preference and the nature of surrounding system configurations.

Typical service voltages available from KPU:

- 120/240V Single-Phase - Typical Residential Service Voltage
- 120/208V Three-Phase Wye
- 120/240V Three-Phase Delta
- 277/480V Three-Phase Wye

When planning your project, please contact KPU's Electric Division to discuss the specifics of your service, including the service size, routing, service entrance and meter equipment details, the project site plan, and determine if there is a requirement for a utility easement agreement. KPU will meet with you onsite to review the project, determine the location of the service entrance and service routing in accordance with the Ketchikan Municipal Code² (KMC), and identifying any vegetation that will need to be removed from the project site.

After review, KPU will develop a not-to-exceed estimate for any work that KPU will be required to perform; full payment is required before any work begins. For residential customers who are developing a new single permanent residence, a Residential Line Extension Credit of two thousand five hundred dollars (\$2,500) may be offered to help offset the costs of installation (KMC 11.06.020).

In some situations, a utility easement agreement may be required by relevant property owners and recorded with the Alaska Department of Natural Resources recorder's office. It is the responsibility of customers to obtain and record all necessary utility easement agreements. Until the utility easement agreement process is completed, KPU will not begin construction on any electric service or line extension.

You will also need to open a new account with KPU Customer Service; a new service connection charge may apply (KMC 11.08.020). Before an account can be opened, it is a requirement to get a City of Ketchikan or Ketchikan Gateway Borough assigned address. For customers inside City limits, a City Building Official will need to inspect and approve the project before an electrical service connection can be made.

KPU, governed by the National Electric Safety Code® (NESCC), is not licensed to perform work, maintenance, or utility locates beyond the utility point of demarcation between the KPU-owned infrastructure and equipment owned by the customer; exceptions include removing and installing KPU-owned meters and installing test equipment at the meter socket of service entrance equipment. The standard **utility point of demarcation** for overhead and underground services is at the weatherhead drip-loop connectors of an overhead service and the first point of attachment on an underground service entrance, as determined by KPU.

¹ <https://www.ktn-ak.us/ketchikan-public-utilities>

² <https://www.codepublishing.com/AK/Ketchikan/>

KPU ELECTRIC SERVICE REQUIREMENTS – RESIDENTIAL

It is the responsibility of the customer or the hired contractor to install all customer-owned equipment, including the service entrance equipment, to the current NFPA 70® National Electric Code (NEC) and KPU standards. KPU recommends that the customer work with a licensed electrical contractor to ensure compliance with all aspects of current standards; other than the information provided in this manual, KPU is not authorized to give guidance or direction on customer-owned equipment, except to provide clarifications on KPU requirements. Throughout this document, reference to “customer” may be the customer or the hired contractor.

In some instances, the customer may be required to hire a licensed contractor to construct portions of a power line extension that KPU would otherwise construct. The contractor is required to work under a valid Electrical Administrator License in the Unlimited Linework Category and each member of the crew performing the work shall hold a valid Power Lineman Journeyman Certificate of Fitness card (8 AAC 90.162³); members of the contract crew may hold Trainee Certificate of Fitness cards (8 AAC 90.165⁴), with an appropriate ratio of Journeyman to Trainees. These requirements are only for contractors constructing KPU-owned infrastructure and not customer-owned infrastructure.

All KPU-owned infrastructures shall be designed and installed to comply with the NESC, KPU standards, and utility engineering practices.

Please complete the ***Electrical Service Request - Residential*** form included in this packet to assist in project planning. KPU looks forward to working with you and will endeavor to complete its work in as timely a manner as schedule and weather allows.

UPGRADES

Customers are not required to upgrade existing service entrance equipment if it is safe, in good condition, functional, and meets the relevant codes and standards that were in force at the time of original installation; these are grandfathered services. In addition, existing service entrance equipment installed on KPU-owned infrastructure will be considered a grandfathered service. However, if the customer elects or is required by code to make upgrades or repairs to their grandfathered service, it shall be brought into compliance with current standards and if installed on KPU-owned infrastructure, it shall be removed or reinstalled on customer-owned property.

GETTING STARTED

The following information provides the departments and organizations that will need to be contacted for permits, accounts, inspections, and coordination for your project. There are additional permits and inspections required if your project is located **within City Limits**, as noted. A ***Residential Service Checklist*** with those minimum requirements is included in this manual. Once you have contacted KPU Electric, determined the size and configuration of your electrical service, and completed ***Electrical***

³ <http://www.akleg.gov/basis/aac.asp#8.90.162>

⁴ <http://www.akleg.gov/basis/aac.asp#8.90.165>

KPU ELECTRIC SERVICE REQUIREMENTS – RESIDENTIAL

Service Request – Residential form, the section **HOW TO USE THIS MANUAL** will help guide you to the applicable requirements of your specific service installation.

- Contact KPU Electric, (907) 225-5505, to complete and submit the **Electrical Service Request – Residential form**, discuss the details of your project, and to schedule an onsite visit from a KPU representative. The site visit will help determine the feasibility of your project, identify a route for utility service conductors, the location of your service entrance, identify any vegetation that may need to be removed, and develop a not-to-exceed estimate for any utility related work. Please have a copy of the completed **Electrical Service Request – Residential** form with you during the site visit. After the site visit, your project information will be forwarded to KPU Metershop to assist with any questions you may have on the specifics of your service entrance equipment.
- A utility easement shall be required if KPU-owned infrastructure, including service conductors, pass through, over, or under an adjacent property, regardless of property ownership. The utility easement will provide a right-of-way for electric and telecommunications infrastructure; the width of the easement must be approved by KPU prior to recording utility easement agreements. KPU is not responsible for requesting, negotiating, completing, or recording a utility easement agreement. The customer is responsible for any fees associated with obtaining the appropriate professional service to complete a utility easement agreement and recording the utility easement agreement; KPU will assist by providing standard utility easement documents for reference. Utility easement agreements must be completed and recorded before KPU will begin construction on any electric service or line extension. All utility easement agreements must be filed with the Alaska Department of Natural Resources; please contact the Juneau Recorder's Office, (907) 465-2514, with any questions about recording. In addition to the Juneau Recorder's Office⁵, completed easement agreements may be recorded through the Ketchikan Gateway Borough Planning and Community Development Department, (907) 228-6610, for an additional service fee.
- Contact the Ketchikan Gateway Borough Planning and Community Development Department, (907) 228-6610, to obtain any required zoning permits.
- **Within City Limits:** Contact the City of Ketchikan Public Works Department, City Building Officials, (907) 228-4727, to obtain a new or updated address, any required building permits, and to schedule inspections (KMC 19.12.040).
- Contact KPU Customer Service, (907) 228-5474, located inside the Plaza Mall at 2417 Tongass Avenue Suite 119D, to set up a new account and request a new or temporary electric service. New KPU customers are required to complete a credit application for electric service. Customer Service will need copies of all permits and relevant paperwork from the Borough Planning Department and (**if within City Limits**) the City of Ketchikan Public Works Department.

⁵ <http://www.dnr.alaska.gov/ssd/recoff/>

KPU ELECTRIC SERVICE REQUIREMENTS – RESIDENTIAL

- **Within City Limits:** The customer shall contact the City Building Officials, (907) 228-4727, when they are ready for an electrical inspection of the service entrance equipment. City Building Officials will *Blue Tag* the service entrance equipment when it passes inspection. After a *Blue Tag*, the customer (or contractor) shall notify KPU Electric, (907) 225-5505, when they are ready for the electric service connection.
- **Outside City Limits:** The customer shall contact KPU Electric, (907) 225-5505, when ready for an electrical inspection of the service entrance equipment. After an approved inspection, the customer shall notify KPU when they are ready for the electric service connection.

KPU ELECTRICAL SERVICE REQUEST – RESIDENTIAL

Customer Information

Name: _____

Address or Location of Service: _____

Mailing Address: _____

Email Address: _____ Phone Number: _____

Contractor Information

Contractor Name: _____

Point of Contact: _____ Phone Number: _____

Type of Request

New Service ---- Will this be your new permanent personal residence? Yes No

Relocation Upgrade Overhead/Underground Conversion

Will temporary construction power be needed?

Yes No

Service Information

Overhead Underground Combination Overhead/Underground

Service Size:

100 Amp 200 Amp 400 Amp Other: _____

Meter Base Mounting:

Building Meter Pole/Post Pedestal

Will there be a back-up generator installed? Yes No

Estimated date service is required to be complete: ____ / ____ / 20____

Property Information

Survey Number: _____ Block: _____ Lot: _____

Plat Number: _____

Are property corners surveyed and marked? Yes No

For property information, contact the Ketchikan Gateway Borough Planning and Community Development at (907) 228-6610.

Other Information and Notes

Signature: _____ Date: ____ / ____ / 20____

After this form is complete, please submit to the KPU Electric front office.

1065 Fair Street Ketchikan, AK 99901

For more information or questions, please call (907) 225-5505

KPU ELECTRIC SERVICE REQUIREMENTS – RESIDENTIAL

PAGE INTENTIONALLY LEFT BLANK

Ketchikan Public Utilities Residential Service Checklist

- Contact KPU Electric for electric service information, (907) 225-5505.
- Complete and submit the ***Electrical Service Request - Residential*** form.
- Schedule onsite visit with KPU personnel, (907) 225-5505.
- Complete onsite visit with KPU personnel.
- Have a KPU approved service route and entrance location.
- If a utility easement agreement is required, it must be recorded before KPU will begin construction on KPU-owned infrastructure and equipment.
- Obtain Zoning Permits from Ketchikan Gateway Borough Planning and Community Development Department, (907) 228-6610.
- Within City Limits**, obtain Building Permits from the City Building Officials at the City of Ketchikan Public Works Department, (907) 228-4727.
- Setup a new electric service account with KPU Customer Service, (907) 228-5474.
- Complete construction of electrical service equipment; service is ready for inspection.
- Within City Limits**, obtain an inspection from City Building Officials for a *Blue Tag*, (907) 228-4727.
- Outside City Limits**, obtain an inspection from KPU Electric to verify the electric service is ready for connection, (907) 225-5505.
- After an approved inspection, contact KPU Electric when ready for connection and meter installation, (907) 225-5505.

KPU ELECTRIC SERVICE REQUIREMENTS – RESIDENTIAL

PAGE INTENTIONALLY LEFT BLANK

KPU ELECTRIC SERVICE REQUIREMENTS – RESIDENTIAL

SECTION 1 – GENERAL SERVICE REQUIREMENTS

1.1 Service Entrance Equipment Location and Access

- 1.1.1 The service entrance location and service routing **shall be** approved by KPU prior to installation (KMC 11.04.210).
- 1.1.2 The service entrance shall be located on the property it is serving.
- 1.1.3 The service entrance equipment shall be accessible from ground level, unless otherwise approved by KPU.
- 1.1.4 The customer shall provide a permanent accessible pathway to the meter location; stairs, paths, and walkways for access shall remain free of all hazards and obstructions.
- 1.1.5 The service entrance equipment **shall have** a clear space maintained in front of it. This clear space shall have a depth of thirty-six (36) inches and a height of eighty-four (84) inches, measured from the surface of the equipment and from final grade. The width shall be either the width of all service entrance equipment or thirty-six (36) inches, whichever is greater, see ***Meter Panel Clearances (Fig. 1)***.

1.2 Service Entrance Equipment

- 1.2.1 All service entrance and metering equipment **shall be** UL Listed⁶, NEMA Type 3R⁷, and be listed as suitable for use as Service Equipment.
- 1.2.2 A main disconnect **shall be** located⁸ on the exterior of a building **and** at the service entrance, unless otherwise approved by the Authority Having Jurisdiction⁹ (AHJ); both requirements are satisfied if the service entrance is located on a building. As per KPU, the main disconnect **shall not** be located inside the building.
- 1.2.3 All equipment shall be in good serviceable condition and free of rust or corrosion; it **shall not** have any exposed energized or potentially energized components.
- 1.2.4 Service entrance equipment shall be installed plumb, level, and securely fastened; KPU requires using heavy duty mounting hardware.
- 1.2.5 Center of the meter socket shall be located five (5) feet plus/minus six (6) inches above finished grade of the ground. The finish grade **shall not be a deck or platform** unless otherwise approved by KPU.
- 1.2.6 Service entrance equipment shall be clearly and permanently labeled with the correct address and information.
- 1.2.7 Buildings or structures with multiple meters shall have them located at one location; locations shall be approved by KPU prior to installation.
- 1.2.8 All conductors shall be protected from physical damage.

⁶ <https://www.ul.com/marks/>

⁷ <https://www.nema.org/Products/Documents/nema-enclosure-types.pdf>

⁸ Inside city limits, the main disconnect location is defined by **KMC 19.12.080 and NEC 230.70 General**. Outside the city limits, KPU and **NEC 230.70 General** define the allowable locations.

⁹ Within city limit the AHJ is the City of Ketchikan City Building Officials and outside city limits it is the State of Alaska Labor Standards and Safety Division – http://labor.alaska.gov/lss/plumbing_electrical.htm.

KPU ELECTRIC SERVICE REQUIREMENTS – RESIDENTIAL

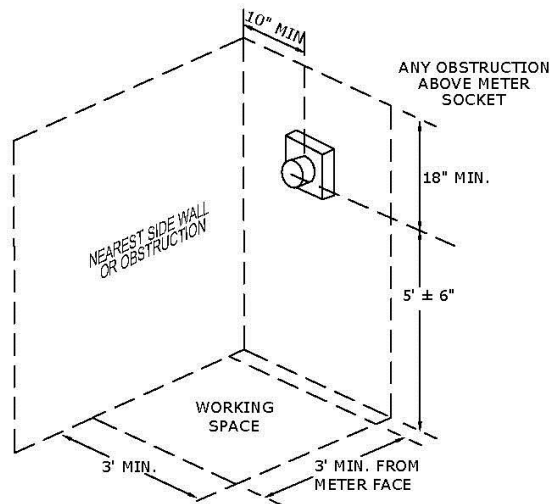
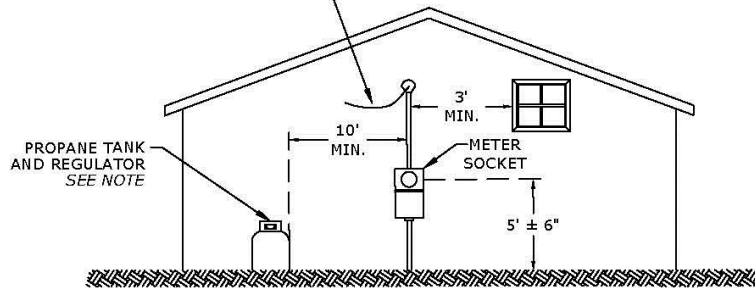
- 1.2.9 All openings shall be sealed by an approved method.
- 1.2.10 Services requiring the use of metallic conduit shall only use hot-dipped galvanized Rigid Metal Conduit (RMC). All galvanized RMC threads¹⁰ shall be coated with an approved electrically conductive, corrosion-resistant compound.

¹⁰ Coatings for this purpose, listed under UL category “FOIZ,” are available. NEC 300.6 Protection Against Corrosion and Deterioration and NEMA Engineering Bulletin No. 96, <https://www.nema.org/Technical/Pages/Engineering-Bulletins.aspx>

METER PANEL CLEARANCES

**FIG. 1
METER PANEL CLEARANCES**

SERVICE ENTRANCE CONDUCTORS MUST BE A MINIMUM OF 3', IN ANY DIRECTION, FROM WINDOWS THAT OPEN, DOORS, PORCHES, DECKS, FIRE ESCAPES, ETC.



NOTE: PROPANE TANKS AND REGULATORS SHALL BE LOCATED IN ACCORDANCE WITH NFPA OR LOCAL CODES. GAS METERS SHALL HAVE 3' MIN. FROM THE METER SOCKET.

KPU ELECTRIC SERVICE REQUIREMENTS – RESIDENTIAL

SECTION 2 – UNDERGROUND SERVICE REQUIREMENTS

There has been a recent increase in interest for underground services in Ketchikan. KPU encourages underground services whenever it proves to be feasible, as it results in a more robust and reliable electrical service for customers.

In general, the customer shall be responsible for installation of the service entrance equipment, removal of vegetation or obstructions, trenching, backfill, and landscaping. KPU will be responsible for providing and installing underground conduit systems and conductor up to the utility point of demarcation. KPU provides and installs the service entrance risers, unless otherwise approved by KPU.

See **Section 5 – Metering Requirements** for metering equipment details.

Note: The common trade use of terms can be slightly different from the NESC definitions. The terms *duct* and *conduit* are sometimes used interchangeably when the conduit consists of only one duct (hole). For the purposes of this section, they are used interchangeably.

2.1 Secondary Trench

- 2.1.1 The customer is responsible for all trench work.
- 2.1.2 A twenty-four (24) inch minimum burial depth shall be required from the top of the conduit.
- 2.1.3 Within State of Alaska Right-of Ways¹¹, the Alaska Department of Transportation¹² (ADOT) requires greater burial depth.
- 2.1.4 Trenches shall be bedded and compacted with clean compactible crushed aggregate D-1 or similar material.
- 2.1.5 KPU will inspect all conduit systems before they are covered by any material.
- 2.1.6 Customer is responsible for all backfill work and materials.
- 2.1.7 Organic or decomposable matter **shall not** be placed in trench.
- 2.1.8 Red electrical warning tape shall be installed and buried at least twelve (12) inches above the conduit.
- 2.1.9 Vegetation, other than grass, **shall not** be planted on the trenching route.
- 2.1.10 For additional KPU and ADOT information, please see the ***Underground Service Examples (Fig. 2 – 7)*** and ***Underground Secondary Trench, Typical (Fig. 8)***.

¹¹ <http://dot.alaska.gov/stwddes/dcsrow/index.shtml>

¹² <http://www.dot.state.ak.us/stwddes/dcsspecs/index.shtml>

KPU ELECTRIC SERVICE REQUIREMENTS – RESIDENTIAL

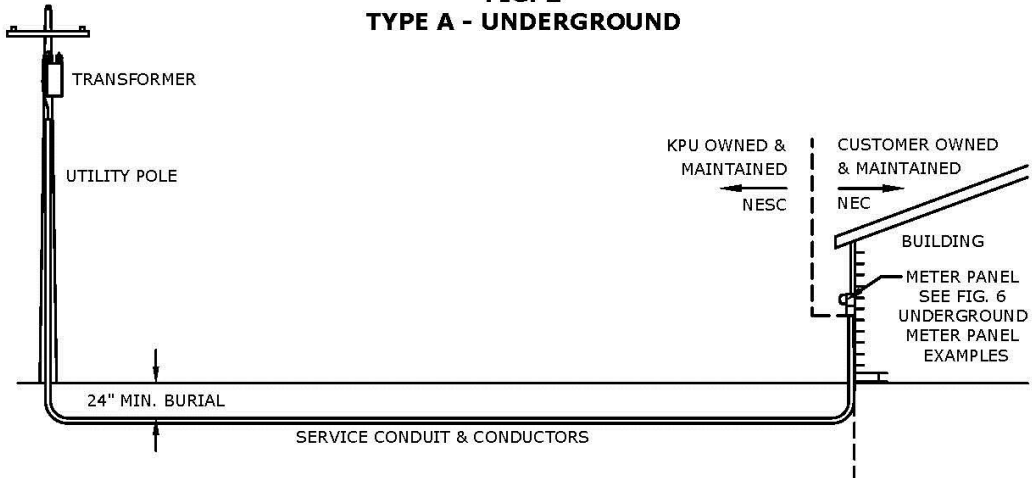
2.2 Secondary Conduit Systems and Conductor

- 2.2.1 KPU provides and installs secondary conduit systems and conductor up to the utility point of demarcation.
- 2.2.2 All conduit system designs and conductor shall be approved by KPU prior to installation.
- 2.2.3 Schedule 80 PVC conduit shall be used unless otherwise directed by KPU.
 - a) Two and one half (2 ½) inch minimum diameter conduit for services up to 400 Amps.
 - b) Services above 400 Amps, KPU will specify the requirement.
- 2.2.4 Conduit bends shall be so made that the conduit will not be damaged and the internal diameter of the conduit will not be effectively reduced.
- 2.2.5 Conduit field bends shall be made only with identified bending equipment.
- 2.2.6 The radius of the curve to the centerline of a conduit bend shall be as required by the manufacture specifications and required standards unless otherwise directed by KPU.
- 2.2.7 There shall be no more than three (3) quarter bends (270 degrees total) between pull points and as determined by a cable pulling calculation, unless otherwise approved by KPU.
- 2.2.8 Conduit expansion fittings or joints may only be used with KPU approval.
- 2.2.9 Conduit shall be installed complete between pull points before installing conductor.
 - a) LB type conduit bodies are **not allowed**.
 - b) Flexible liquid tight conduit is **not allowed** unless otherwise approved by KPU in temporary service construction, see **Section 6.3 Temporary Services**.
- 2.2.10 Direct bury of KPU-owned conductors is **not allowed** between the transformer, pedestal, and/or the utility point of demarcation.
- 2.2.11 Risers subject to physical damage shall be galvanized RMC, including the radius sweep.
- 2.2.12 If used, galvanized RMC in contact with soil shall have a supplementary corrosion protection¹³ (e.g. tape wrap, shrink wrap, paints approved for the purpose, etc.) applied, unless otherwise approved by KPU.
- 2.2.13 Risers shall have straps within three (3) feet of the service entrance equipment; customers shall provide on customer-owned buildings or structures a means to attach straps and hardware.
- 2.2.14 KPU requests that the customer provide a notch through the foundation footer to allow KPU service entrance risers a clear path to bottom of service entrance equipment.

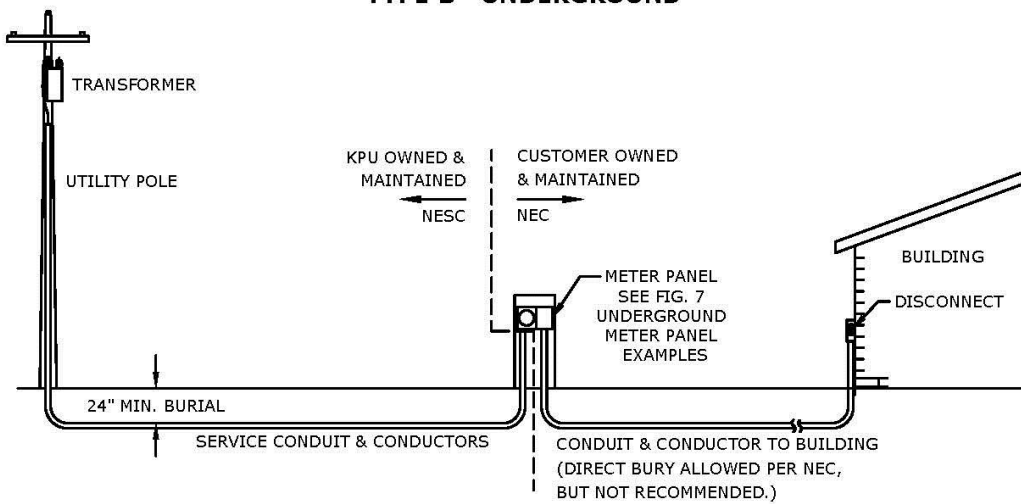
¹³NEMA Engineering Bulletin No. 96, <https://www.nema.org/Technical/Pages/Engineering-Bulletins.aspx>

UNDERGROUND SERVICE EXAMPLES

**FIG. 2
TYPE A - UNDERGROUND**

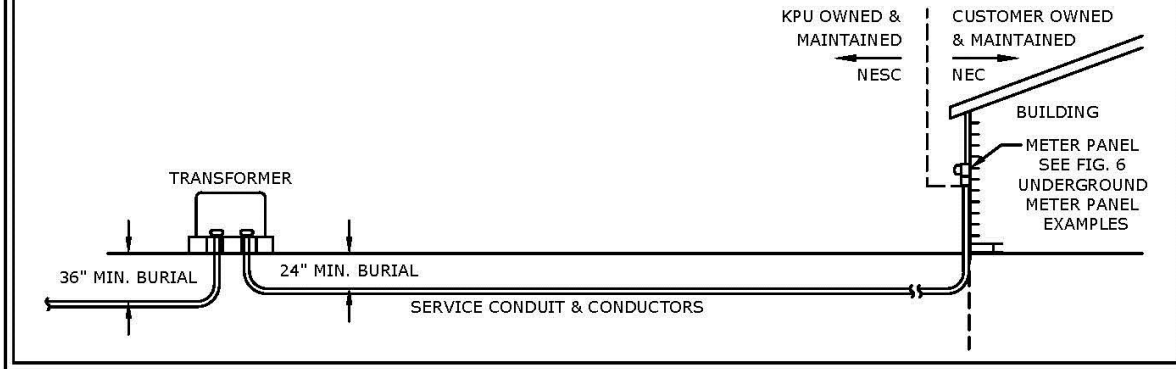


**FIG. 3
TYPE B - UNDERGROUND**

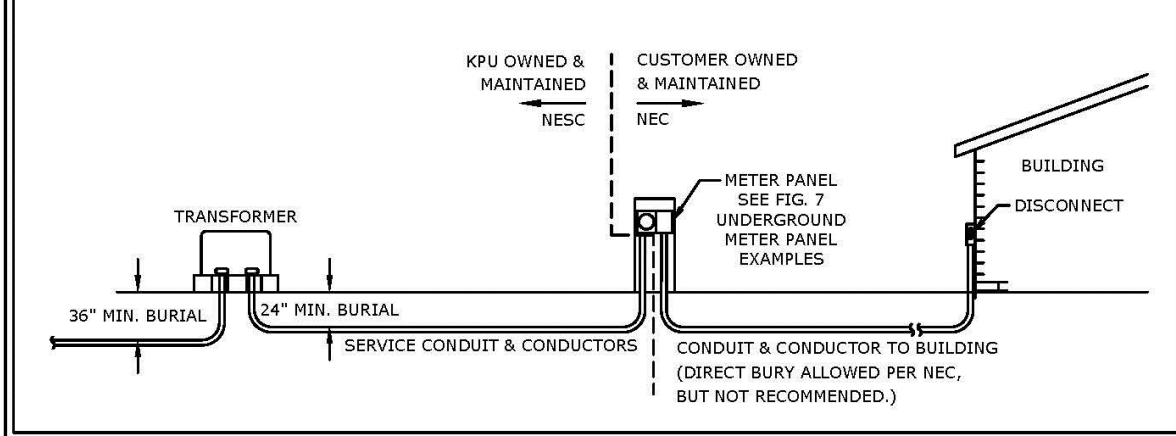


UNDERGROUND SERVICE EXAMPLES (cont.)

**FIG. 4
TYPE C - UNDERGROUND**

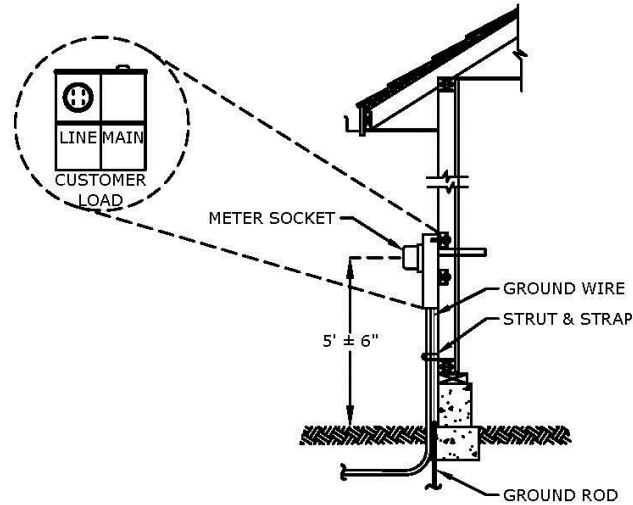


**FIG. 5
TYPE D - UNDERGROUND**

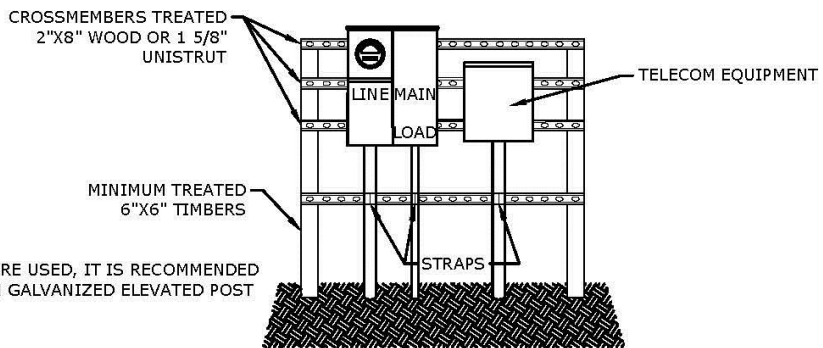


UNDERGROUND METER PANEL EXAMPLES

**FIG. 6
SURFACE MOUNT UNDERGROUND METER PANEL**



**FIG. 7
PEDESTAL UNDERGROUND METER PANEL**



NOTE:
IF CONCRETE FOOTERS ARE USED, IT IS RECOMMENDED THAT TIMBERS BE SET IN GALVANIZED ELEVATED POST BASES.

GROUNDING & BONDING

THE METER PANEL MUST HAVE EITHER:

- TWO GROUND RODS THAT ARE VISIBLY CONNECTED AND PROPERLY DRIVEN WITH 6 FEET BETWEEN THEM, OR;
- ONE GROUND ROD THAT IS VISIBLY CONNECTED AND PROPERLY DRIVEN AND A COPPER GROUND ELECTRODE CONDUCTOR CONNECTED EITHER TO THE BUILDING'S WATER PIPING OR TO A CONCRETE ENCASED "UFER" GROUND.

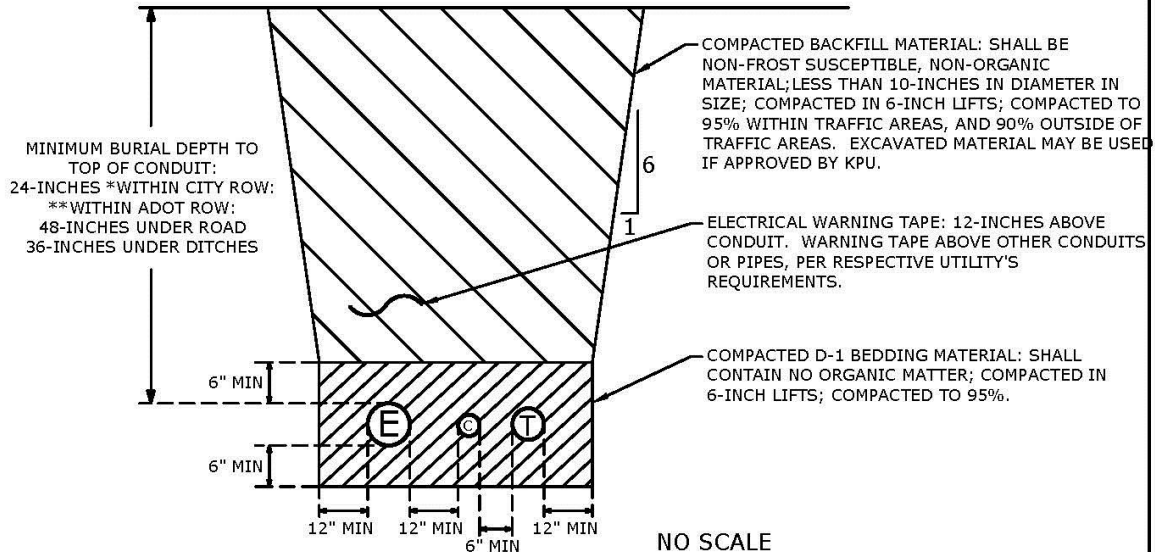
100 AMP SERVICES - CONNECT WITH #6 COPPER GROUNDING ELECTRODE CONDUCTOR.

200 AMP SERVICES - CONNECT WITH #4 COPPER GROUNDING ELECTRODE CONDUCTOR.

400 AMP SERVICES - CONNECT WITH #4 COPPER GROUNDING ELECTRODE CONDUCTOR.

UNDERGROUND SECONDARY TRENCH, TYPICAL

**FIG. 8
PADMOUNTED TRANSFORMER/PEDESTAL TO METER PANEL**



SHEET NOTES:

- ANY EXCAVATION WITHIN KETCHIKAN CITY LIMITS REQUIRES A PERMIT TO EXCAVATE, ISSUED BY THE CITY'S PUBLIC WORKS DEPARTMENT
- FOR ASPHALT/CONCRETE PATCHING IN A CITY OF KETCHIKAN OR STATE OF ALASKA DEPARTMENT OF TRANSPORTATION (ADOT) RIGHT-OF-WAY (ROW), CONTACT RESPECTIVE ENTITY FOR SPECIFIC PATCHING REQUIREMENTS

GENERAL NOTES:

- TRENCHING EXCAVATION AND SHORING SHALL COMPLY WITH LOCAL, STATE, AND OSHA REGULATIONS
- DIRECT-BURIAL OF KPU ELECTRICAL CONDUCTORS IS NOT PERMITTED
- ELECTRICAL CONDUIT SIZES:
 - 200 AMP OR LESS: 2-1/2 INCH MINIMUM
 - 400 AMP: 4 INCH MINIMUM
 - GREATER THAN 400 AMP: PER LOAD REQUIREMENTS
- MAXIMUM 90-DEGREES OF ANGLE IN A SINGLE BEND
- MAXIMUM 270-DEGREES OF TOTAL ANGLE IN A RUN OF CONDUIT
- LONG-SWEEP ELBOWS MAY BE REQUIRED FOR SOME INSTALLATIONS
- IF OBTAINING MINIMUM BURIAL DEPTH IS NOT PROBABLE, CONCRETE CAPPING OPTIONS MAY BE POSSIBLE ON A CASE-BY-CASE BASIS
- OTHER CONDUITS PER RESPECTIVE UTILITY'S REQUIREMENTS

ADOT NOTES:

- SHALL BACKFILL AND COMPACT ALL TRENCHES WITHIN ROAD PRISMS AND PATHWAYS IN 6-INCH LIFTS OR ACCEPTED BY ADOT. 6-INCH LIFTS ARE REQUIRED IF NO INSPECTOR IS PRESENT. THE BACKFILL SHALL BE OF SUITABLE NON-FROST SUSCEPTIBLE, NON-ORGANIC MATERIAL (0-6% PASSING NO. 200 SIEVE). ALL EXCAVATED NON-ACCEPTABLE MATERIAL SHALL BE REMOVED FROM THE STATE RIGHT-OF-WAY OR PROPERTY.
- THE ROAD PRISM IS DEFINED TO INCLUDE THE FINISHED ROADWAY SURFACE AND UNDERLYING STRUCTURAL LAYERS OUT TO, AND INCLUDING, ANY UNPAVED SHOULDER, CURBS, AND ATTACHED PATHWAYS.
- SHALL COMPACT ALL TRENCHES WITHIN OR CROSSING ROAD PRISMS AND PATHWAYS AT A MINIMUM OF 95% OF THE OPTIMUM DENSITY. COMPACTION TEST RESULTS WILL BE SUBMITTED TO ADOT.
- SHALL BACKFILL ALL TRENCHES, BORE PITS, AND OTHER EXCAVATIONS LOCATED OUTSIDE ROAD AND PATHWAY PRISMS WITH CLEAN, NON-ORGANIC, AND COMPACTABLE MATERIAL MEETING THE REQUIREMENTS OF ADOT. EXISTING MATERIAL IS ACCEPTABLE AS BACKFILL PROVIDED IT MEETS THE REQUIREMENTS OF ADOT.
- SHALL REMOVE MATERIAL NOT SUITABLE FOR USE AS BACKFILL FROM THE SITE. SHALL REPLACE UNSUITABLE BACKFILL MATERIAL WITH IMPORTED MATERIAL MEETING THE REQUIREMENTS OF ADOT.
- ALL BACKFILL SHALL BE COMPACTED TO EXISTING UNDISTURBED SOIL DENSITIES OR BETTER, AND GRADED TO BLEND WITH THE EXISTING ROAD SURFACE.
- THE TOP SIX (6) INCHES OF THE ROAD SURFACE OR SURFACE UNDER PAVEMENT SHALL BE CRUSHED AGGREGATE D-1.

KPU ELECTRIC SERVICE REQUIREMENTS – RESIDENTIAL

2.3 Primary Line Extension

In some circumstances, a primary line extension may be necessary to provide new service to the customer. In those cases, the customer will be responsible for removal of vegetation or obstructions, trenching, backfill, and landscaping. KPU will be responsible for installation of all primary conduit systems, conductors, and KPU-owned equipment. As stated in the introduction, in some instances, the customer may be required to hire a properly licensed contractor to construct portions of a power line extension that KPU would otherwise construct.

2.4 Primary Trench

- 2.4.1 Customer is responsible for all trench work.
- 2.4.2 A thirty-six (36) inch minimum burial depth shall be required from the top of the conduit.
- 2.4.3 Within State of Alaska right-of ways, ADOT requires greater burial depth.
- 2.4.4 Trenches shall be bedded and compacted with clean compactible crushed aggregate D-1 or similar material.
- 2.4.5 KPU will inspect all conduit systems before they are covered by any material.
- 2.4.6 Customer is responsible for all backfill work and materials.
- 2.4.7 Organic or decomposable matter **shall not** be placed in trench.
- 2.4.8 Red electrical warning tape shall be installed and buried at least twelve (12) inches above the conduit.
- 2.4.9 Vegetation, other than grass, **shall not** be planted on the trenching route.
- 2.4.10 For additional ADOT and KPU information, please see the ***Underground Primary Trench, Typical (Fig. 9)***.

2.5 Primary Conduit Systems and Conductor

- 2.5.1 KPU provides and installs all primary conduit systems and conductor up to the point of demarcation.
- 2.5.2 All conduit system designs and conductor shall be approved by KPU prior to installation.
- 2.5.3 Schedule 80 PVC conduit shall be used unless otherwise directed by KPU.
 - a) Two (2) inch minimum diameter conduit shall be used for single-phase.
 - b) Four (4) inch minimum diameter conduit shall be used for three-phase.
- 2.5.4 Conduit bends shall be so made that the conduit will not be damaged and the internal diameter of the conduit will not be effectively reduced.
- 2.5.5 Conduit field bends shall be made only with identified bending equipment.
- 2.5.6 The radius of the curve to the centerline of a conduit bend shall be as required by the manufacture specification and required standards unless otherwise directed by KPU.
- 2.5.7 There shall be no more than three (3) quarter bends (270 degrees total) between pull points and as determined by a cable pulling calculation, unless otherwise approved by KPU.

KPU ELECTRIC SERVICE REQUIREMENTS – RESIDENTIAL

- 2.5.8 Conduit expansion fittings or joints may only be used with KPU approval.
- 2.5.9 Conduits shall be installed complete between pull points before installing conductor.
- 2.5.10 Risers subject to physical damage shall be galvanized RMC, including the radius sweep.
- 2.5.11 If used, galvanized RMC in contact with soil shall have a supplementary corrosion protection¹⁴ (e.g. tape wrap, shrink wrap, paints approved for the purpose, etc.) applied, unless otherwise approved by KPU.
- 2.5.12 Risers shall have straps within three (3) feet of the service entrance equipment or as required by KPU; customers shall provide on customer-owned buildings or structures a means to attach straps and hardware.

2.6 Vegetation and Obstructions

The customer shall be responsible for removal any vegetation or obstructions that KPU determines is a hazard or obstruction for providing electrical service.

2.7 Landscaping

The customer shall be responsible for landscaping required due to underground utility service installations of primary lines and between the utility transformer or secondary pedestal and the service entrance location.

2.8 Padmounted Transformer

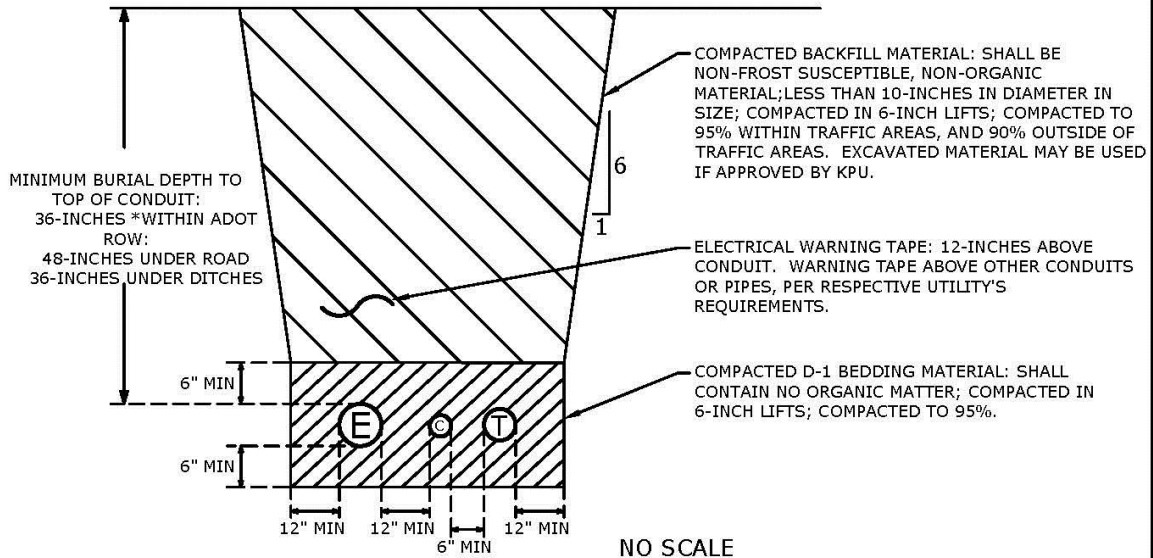
- 2.8.1 Clearances between padmount transformers and buildings or structures shall be measured from the metal portion of the transformer closest to the building or structure, including any overhangs within the clearances.
- 2.8.2 Unobstructed access shall be maintained.
- 2.8.3 No structure shall be built over the top of the transformer.
- 2.8.4 Location restrictions¹⁵:
 - a) No obstructions or objects shall be placed within ten (10) feet of the front of the transformer door or access or within three (3) feet of any other side.
 - b) Three (3) feet from non-combustible walls (e.g. brick, concrete, steel, etc.) or gas meters.
 - c) Six (6) feet from fire sprinkler valves, standpipes, and fire hydrants.
 - d) Ten (10) feet from combustible walls, edge of egress doors or windows, exhaust vents, and other building or structure openings.
 - e) Fifteen (15) feet from any open water source.
 - f) Twenty (20) feet in front of an egress door or window, air intake, propane regulator, or any source of stored hazardous liquids, fuels, or gases.
- 2.8.5 Transformers shall be installed on a KPU approved foundation.
- 2.8.6 KPU will only allow KPU-specified and ordered transformers.

¹⁴ NEMA Engineering Bulletin No. 96, <https://www.nema.org/Technical/Pages/Engineering-Bulletins.aspx>

¹⁵ Location shall meet KPU Requirements, **NEC 450.27 Oil-Insulated Transformers Installed Outside**, and **NESC Section 152(A) Location and arrangement of power transformers and regulators**.

UNDERGROUND PRIMARY TRENCH, TYPICAL

**FIG. 9
POWER POLE TO PADMOUNTED TRANSFORMER/PEDESTAL**



SHEET NOTES:

- ANY EXCAVATION WITHIN KETCHIKAN CITY LIMITS REQUIRES A PERMIT TO EXCAVATE, ISSUED BY THE CITY'S PUBLIC WORKS DEPARTMENT
- FOR ASPHALT/CONCRETE PATCHING IN THE CITY OF KETCHIKAN OR STATE OF ALASKA DEPARTMENT OF TRANSPORTATION (ADOT) RIGHT-OF-WAY (ROW), CONTACT RESPECTIVE ENTITY FOR SPECIFIC PATCHING REQUIREMENTS

GENERAL NOTES:

- TRENCHING EXCAVATION AND SHORING SHALL COMPLY WITH LOCAL, STATE, AND OSHA REGULATIONS
- DIRECT-BURIAL OF KPU ELECTRICAL CONDUCTORS IS NOT PERMITTED
- ELECTRICAL CONDUIT SIZES:
 - SINGLE-PHASE: 2-INCH MINIMUM
 - THREE-PHASE: 4-INCH MINIMUM
- MAXIMUM 90-DEGREES OF ANGLE IN A SINGLE BEND
- MAXIMUM 270-DEGREES OF TOTAL ANGLE IN A RUN OF CONDUIT
- LONG-SWEEP ELBOWS MAY BE REQUIRED FOR SOME INSTALLATIONS
- IF OBTAINING MINIMUM BURIAL DEPTH IS NOT PROBABLE, CONCRETE CAPPING OPTIONS MAY BE POSSIBLE ON A CASE-BY-CASE BASIS
- OTHER CONDUITS PER RESPECTIVE UTILITY'S REQUIREMENTS

ADOT NOTES:

- SHALL BACKFILL AND COMPACT ALL TRENCHES WITHIN ROAD PRISMS AND PATHWAYS IN 6-INCH LIFTS OR ACCEPTED BY ADOT. 6-INCH LIFTS ARE REQUIRED IF NO INSPECTOR IS PRESENT. THE BACKFILL SHALL BE OF SUITABLE NON-FROST SUSCEPTIBLE, NON-ORGANIC MATERIAL (0-6% PASSING NO. 200 SIEVE). ALL EXCAVATED NON-ACCEPTABLE MATERIAL SHALL BE REMOVED FROM THE STATE RIGHT-OF-WAY OR PROPERTY.
- THE ROAD PRISM IS DEFINED TO INCLUDE THE FINISHED ROADWAY SURFACE AND UNDERLYING STRUCTURAL LAYERS OUT TO, AND INCLUDING, ANY UNPAVED SHOULDER, CURBS, AND ATTACHED PATHWAYS.
- SHALL COMPACT ALL TRENCHES WITHIN OR CROSSING ROAD PRISMS AND PATHWAYS AT A MINIMUM OF 95% OF THE OPTIMUM DENSITY. COMPACTION TEST RESULTS WILL BE SUBMITTED TO ADOT.
- SHALL BACKFILL ALL TRENCHES, BORE PITS, AND OTHER EXCAVATIONS LOCATED OUTSIDE ROAD AND PATHWAY PRISMS WITH CLEAN, NON-ORGANIC, AND COMPACTABLE MATERIAL MEETING THE REQUIREMENTS OF ADOT. EXISTING MATERIAL IS ACCEPTABLE AS BACKFILL PROVIDED IT MEETS THE REQUIREMENTS OF ADOT.
- SHALL REMOVE MATERIAL NOT SUITABLE FOR USE AS BACKFILL FROM THE SITE. SHALL REPLACE UNSUITABLE BACKFILL MATERIAL WITH IMPORTED MATERIAL MEETING THE REQUIREMENTS OF ADOT.
- ALL BACKFILL SHALL BE COMPACTED TO EXISTING UNDISTURBED SOIL DENSITIES OR BETTER, AND GRADED TO BLEND WITH THE EXISTING ROAD SURFACE.
- THE TOP SIX (6) INCHES OF THE ROAD SURFACE OR SURFACE UNDER PAVEMENT SHALL BE CRUSHED AGGREGATE D-1.

KPU ELECTRIC SERVICE REQUIREMENTS – RESIDENTIAL

SECTION 3 – OVERHEAD SERVICE REQUIREMENTS

Overhead services have long been the traditional type of installation in the KPU service area. However, overhead services are also more prone to service interruptions caused by wildlife, vegetation, or inclement weather.

For an overhead installation, the customer shall be responsible for installation of the service entrance equipment, service mast and weatherhead, secondary conductor from the utility point of demarcation, and removal of vegetation or obstructions for the service drop route. KPU will be responsible for determining the service drop path and providing and installing overhead secondary conductor up to the utility point of demarcation.

See **Section 5 – Metering Requirements** for metering equipment details.

3.1 Weatherhead, Mast, and Drip Loop

- 3.1.1 The weatherhead shall be installed high enough to ensure proper clearances. At minimum, the weatherhead shall be thirteen (13) feet above finished grade. The bottom of the drip loop shall be a minimum of twelve (12) feet above finished grade and no less than eighteen (18) inches above the roof.
- 3.1.2 The weatherhead may require a higher installation height to meet the vertical clearances for the service drop as defined in **Section 3.3 - Vertical Clearances**.
- 3.1.3 The weatherhead and service conductors shall be a minimum of thirty-six (36) inches from windows, doors, porches, decks, fire escapes, or similar locations, see Figure under **Section 1 – General Service Requirements**.
- 3.1.4 The weatherhead **shall not** be located under eaves due to the potential of snow to slide off the roof onto the service; installations of snow stops on the roof do not nullify this requirement.
- 3.1.5 A minimum of twenty-four (24) inches of service entrance conductors shall be left beyond the weatherhead for attachment to the overhead service conductor from the Utility.
- 3.1.6 The weatherhead **shall not** be plastic or PVC.
- 3.1.7 The mast for the weatherhead shall be galvanized RMC and be two (2) inches minimum, or greater as determined by the NEC.
- 3.1.8 The mast shall be attached to the meter panel or enclosure by a UL Listed watertight NEMA type 3R hub.
- 3.1.9 For services over 400 Amps, riser conduit size and quantity must be approved by KPU.
- 3.1.10 The top portion of mast shall be ten (10) continuous feet without couplings from the weatherhead down; conduit couplings shall be at least two (2) feet below the roofline and supported above the coupling.
- 3.1.11 The mast shall be solidly attached, installed plumb, securely fastened, and shall not be bent or damaged; KPU requires using heavy duty mounting hardware.
- 3.1.12 If the weatherhead is greater than three (3) feet above roof line, KPU shall require the mast be properly guyed.

KPU ELECTRIC SERVICE REQUIREMENTS – RESIDENTIAL

- 3.1.13 An eyebolt shall be used as the point of attachment for service drops below the gable end. A minimum one-half (½) inch eyebolt with a minimum one and one-half (1 ½) inch eye opening shall be securely installed within two (2) feet of the weatherhead below the gable end.
- 3.1.14 Telecommunications cables **shall not** be attached to or supported by the electrical weatherhead or electrical mast.

3.2 Vegetation and Obstructions

It is the responsibility of the customer to remove any vegetation or obstructions that KPU determines is a hazard or obstruction for providing electrical service.

3.3 Vertical Clearances – KPU-Owned Secondary Conductors (Less than 750V)

- 3.3.1 State of Alaska highways/right-of-ways: minimum twenty (20) feet to the lowest conductor or cable.
- 3.3.2 Other roads and streets: minimum of eighteen (18) feet.
- 3.3.3 Driveways, parking lots, alleys: minimum of sixteen (16) feet.
- 3.3.4 Pedestrian or restricted vehicle traffic areas: minimum of twelve (12) feet.
- 3.3.5 Roof with service wires crossing, if not readily accessible: minimum of three (3) feet.
- 3.3.6 Roof of building or structure not being serviced by the crossing service wires, if not readily accessible: minimum of three and one-half (3 ½) feet.
- 3.3.7 Roof, if readily accessible: minimum of ten (10) feet.
- 3.3.8 Decks and porches: minimum of twelve (12) feet.
- 3.3.9 For more information please see the ***Minimum Overhead Clearances (Fig. 15-16)***.

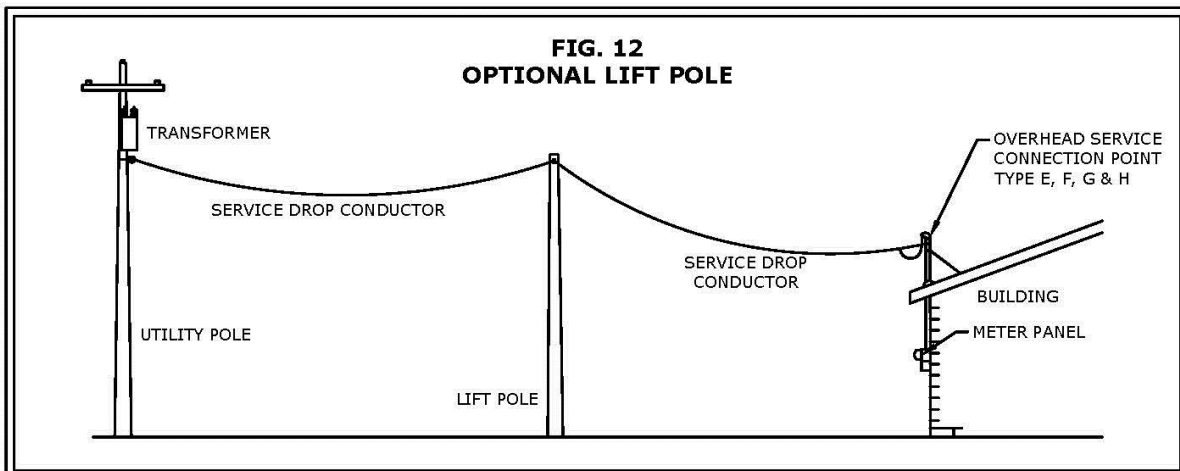
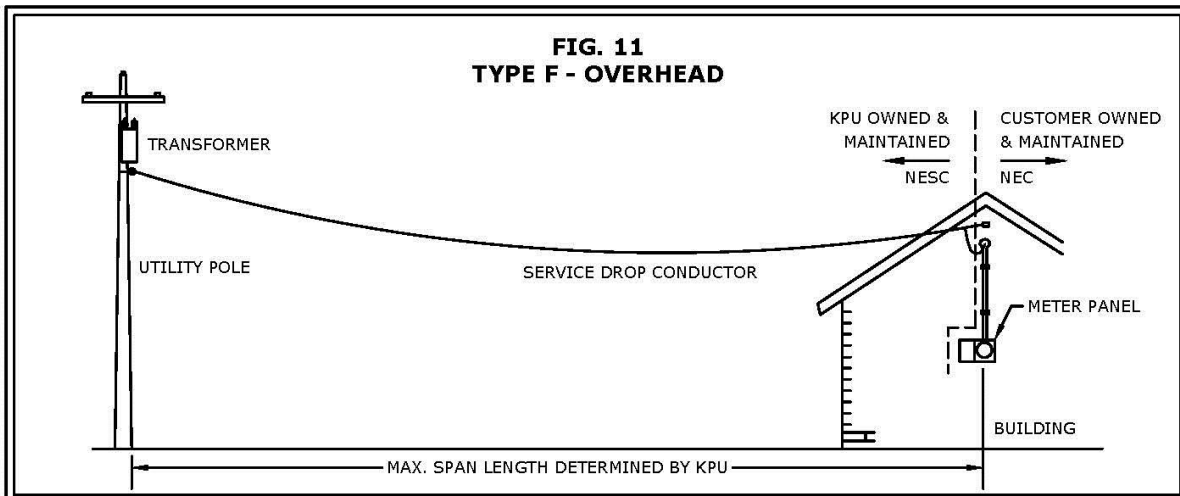
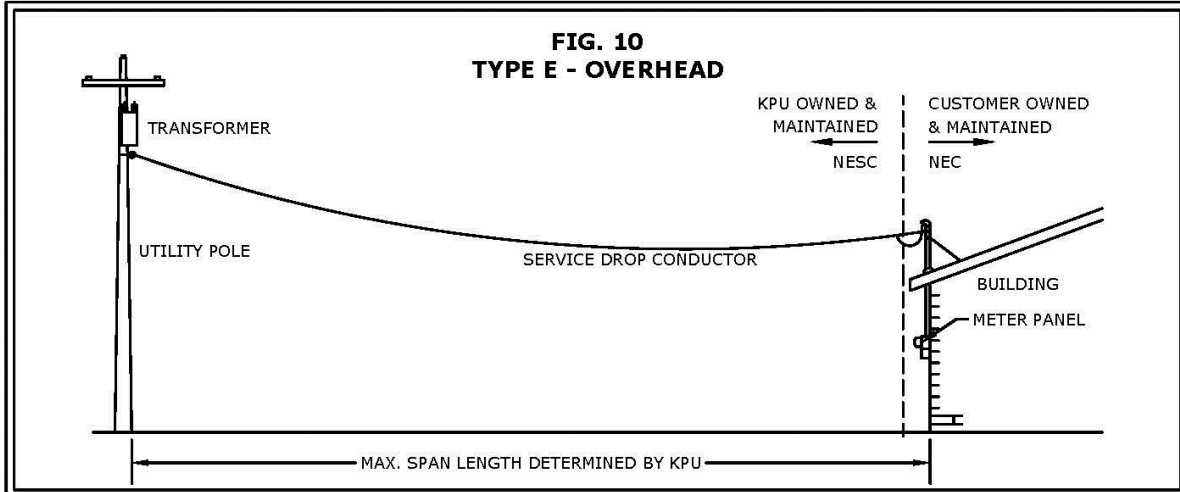
3.4 Maximum Span Lengths

Maximum span lengths will be determined by KPU.

3.5 Meter Poles and Posts

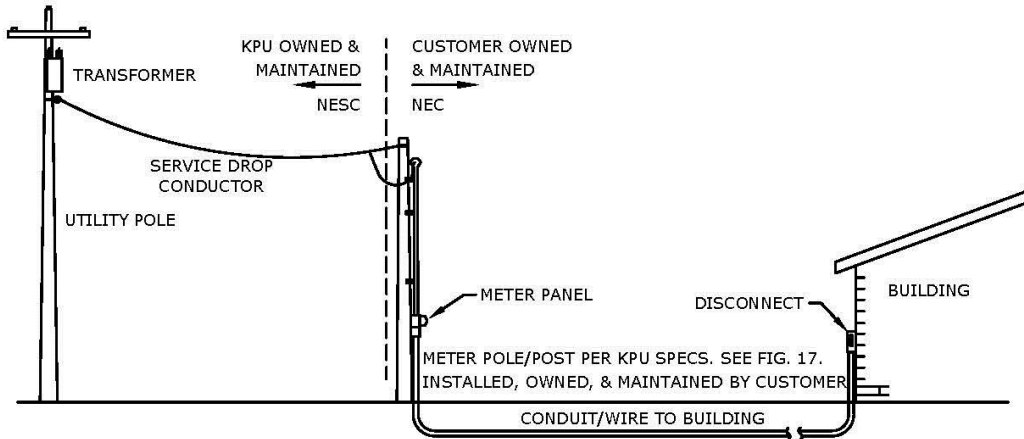
- 3.5.1 Meter poles/posts are owned, installed, and maintained by the customer.
- 3.5.2 Meter pole, if used, shall be a minimum ANSI 05.1 Class 5 pressure treated or cedar, **creosote is not allowed.**
- 3.5.3 Meter post, if used, shall be a minimum of six (6) inches by six (6) inches (6"x6") and shall be pressure treated or cedar.
- 3.5.4 Meter poles/post shall be properly installed and use guy wires, if required.
- 3.5.5 For more information please see the ***Meter Pole/Post Specification (Fig. 17-18)***.

OVERHEAD SERVICE EXAMPLES

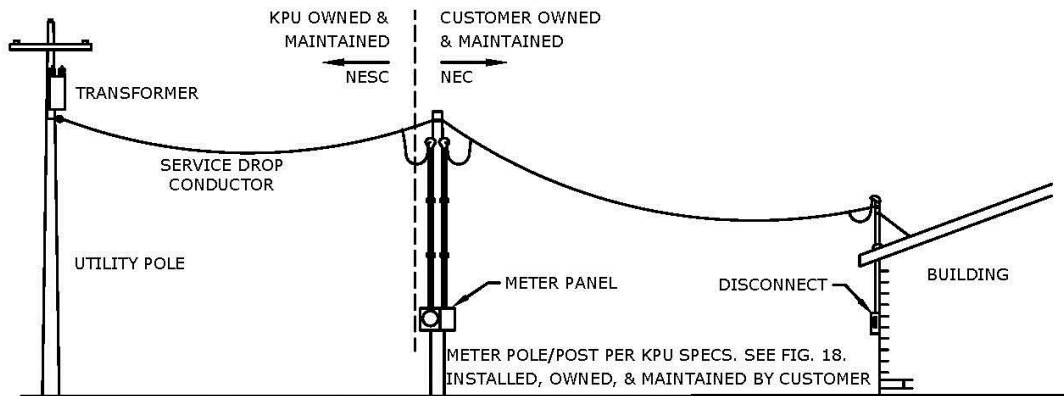


OVERHEAD SERVICE EXAMPLES (cont.)

**FIG. 13
TYPE G - OVERHEAD**

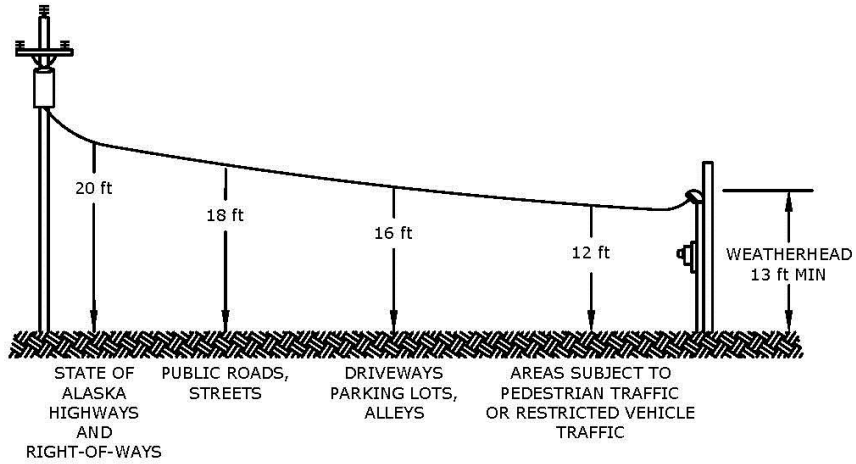


**FIG. 14
TYPE H - OVERHEAD**

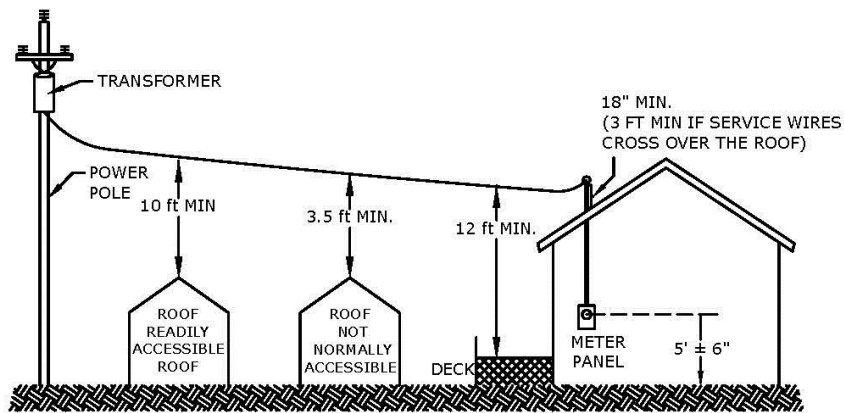


MINIMUM OVERHEAD CLEARANCES

**FIG. 15
ROADWAYS AND WALKWAYS**

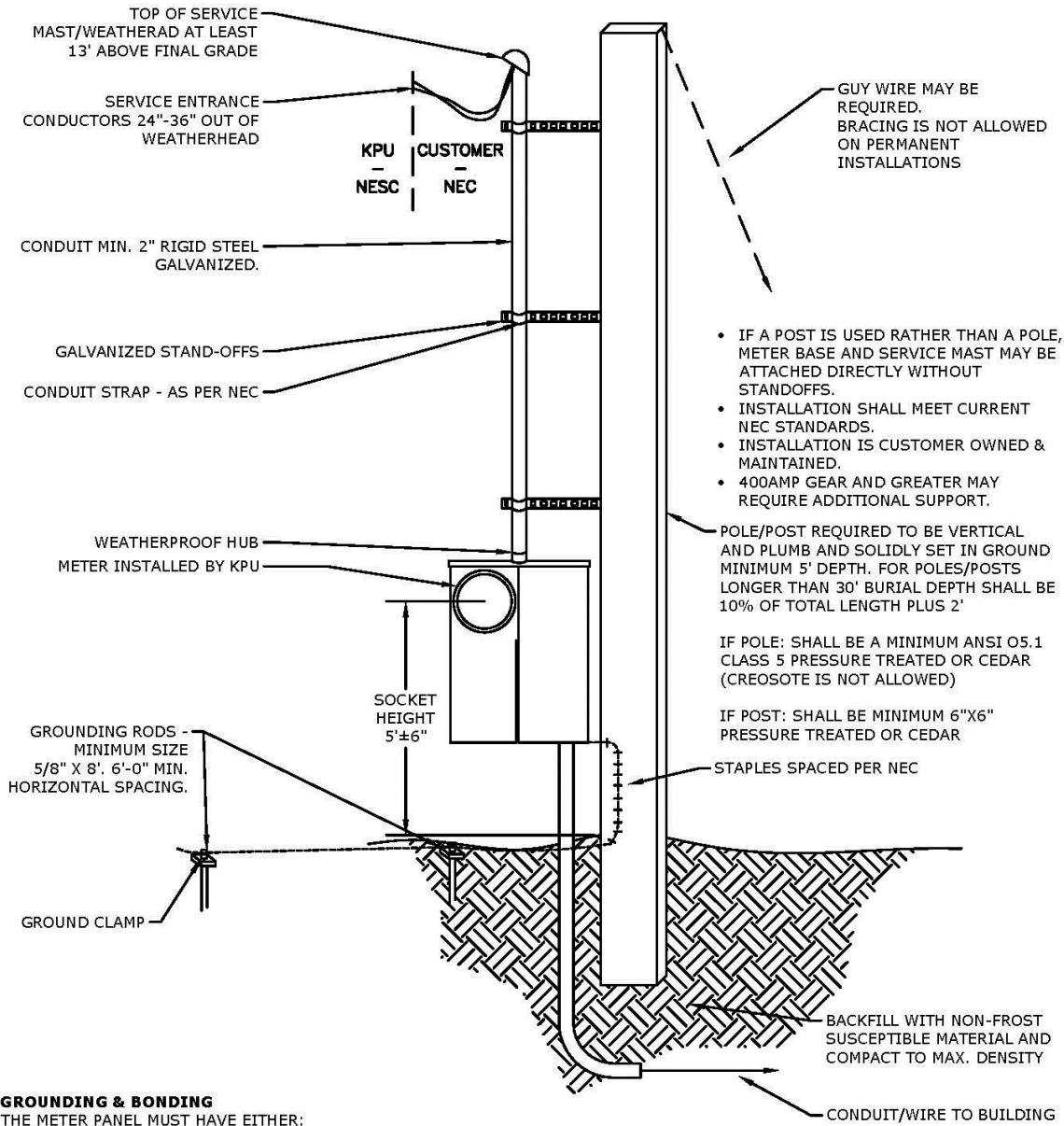


**FIG. 16
PRIVATE PROPERTY STRUCTURES**



METER POLE/POST SPECIFICATION - TYPE G

**FIG. 17
PERMANENT INSTALLATION
OVERHEAD TO UNDERGROUND**



GROUNDING & BONDING

THE METER PANEL MUST HAVE EITHER:

- TWO GROUND RODS THAT ARE VISIBLY CONNECTED AND PROPERLY DRIVEN WITH 6 FEET BETWEEN THEM, OR;
- ONE GROUND ROD THAT IS VISIBLY CONNECTED AND PROPERLY DRIVEN AND A COPPER GROUND ELECTRODE CONDUCTOR CONNECTED EITHER TO THE BUILDING'S WATER PIPING OR TO A CONCRETE ENCASED "UFER" GROUND.

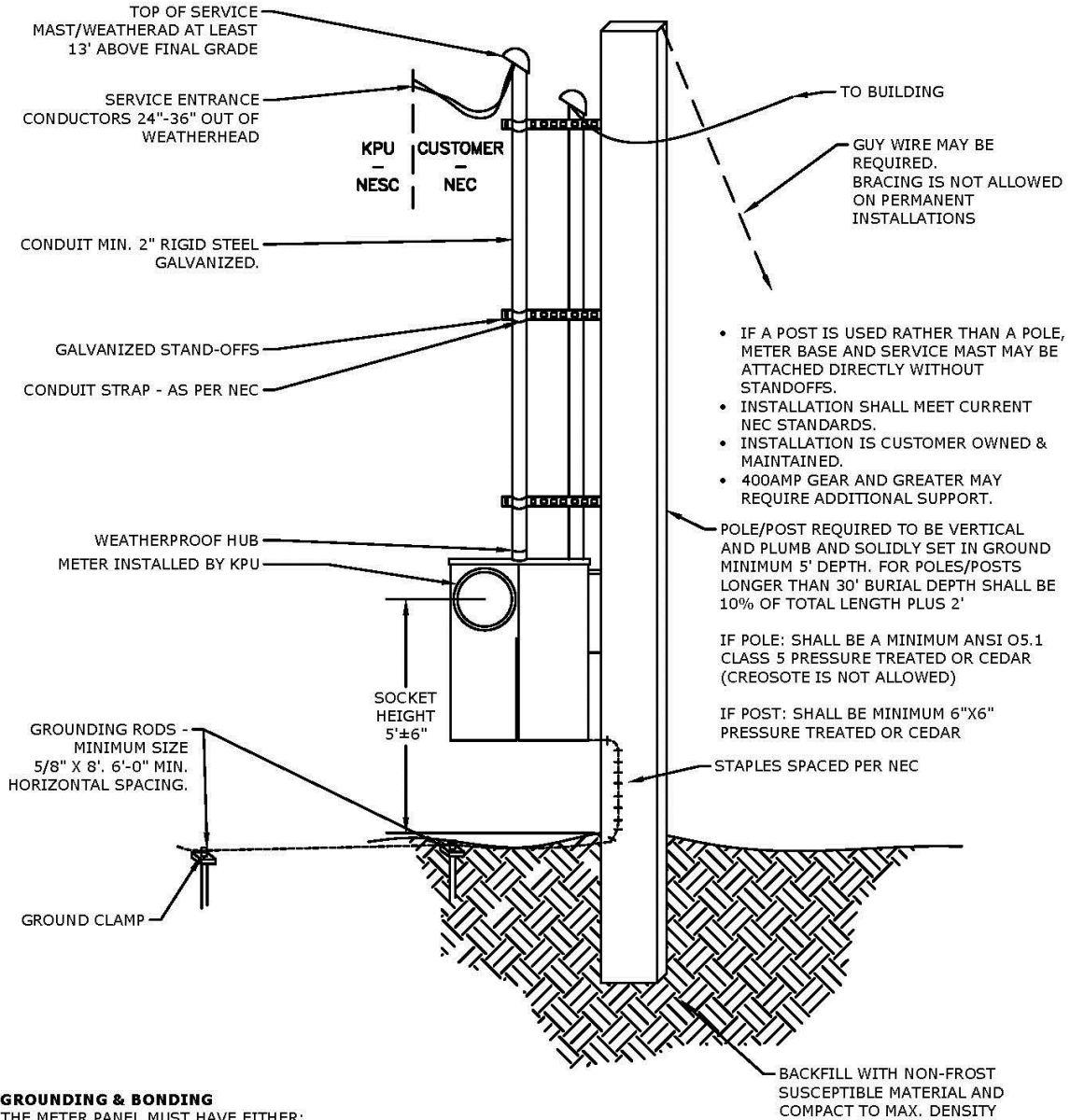
100 AMP SERVICES - CONNECT WITH #6 COPPER GROUNDING ELECTRODE CONDUCTOR.

200 AMP SERVICES - CONNECT WITH #4 COPPER GROUNDING ELECTRODE CONDUCTOR.

400 AMP SERVICES - CONNECT WITH #4 COPPER GROUNDING ELECTRODE CONDUCTOR.

METER POLE/POST SPECIFICATION - TYPE H

**FIG. 18
PERMANENT INSTALLATION
OVERHEAD TO OVERHEAD**



GROUNDING & BONDING

THE METER PANEL MUST HAVE EITHER:

- TWO GROUND RODS THAT ARE VISIBLY CONNECTED AND PROPERLY DRIVEN WITH 6 FEET BETWEEN THEM, OR;
- ONE GROUND ROD THAT IS VISIBLY CONNECTED AND PROPERLY DRIVEN AND A COPPER GROUND ELECTRODE CONDUCTOR CONNECTED EITHER TO THE BUILDING'S WATER PIPING OR TO A CONCRETE ENCASED "UFER" GROUND.

100 AMP SERVICES - CONNECT WITH #6 COPPER GROUNDING ELECTRODE CONDUCTOR.

200 AMP SERVICES - CONNECT WITH #4 COPPER GROUNDING ELECTRODE CONDUCTOR.

400 AMP SERVICES - CONNECT WITH #4 COPPER GROUNDING ELECTRODE CONDUCTOR.

KPU ELECTRIC SERVICE REQUIREMENTS – RESIDENTIAL

SECTION 4 – GROUNDING AND BONDING REQUIREMENTS

Electric services shall comply with all applicable grounding and bonding requirements of the **NEC Article 250 Grounding and Bonding** and KPU standards. The customer is responsible for furnishing, installing and maintaining the components of the grounding and bonding system at the utility point of connection and within the premises wiring system to comply with the NEC.

4.1 Grounding Electrode Systems

- 4.1.1 The grounding electrode system shall have a minimum of two (2) grounding electrodes, a grounding electrode system and one (1) rod-type grounding electrode or two (2) rod-type grounding electrodes.
- 4.1.2 Grounding electrode systems may consist of metal underground water pipes, structural steel, concrete-encased electrodes, and are defined in **NEC 250.50 Grounding Electrode System**.
- 4.1.3 For buildings and structures with concrete footings, KPU recommends the use of concrete-encased electrodes as part of the grounding electrode system, **NEC 250.52(A)(3) Concrete-Encased Electrode**.
- 4.1.4 In addition to available electrode systems, the rod-type grounding electrode(s) shall be installed at the service entrance equipment.
- 4.1.5 Rod-type grounding electrode(s) shall be properly driven, visibly connected, and installed in accordance with the requirements below.
- 4.1.6 The rod-type grounding electrode shall be copper (Cu), no less than five-eighths (5/8) inches in diameter, and no less than eight (8) feet in length.
- 4.1.7 The rod-type grounding electrode shall be placed a minimum of thirty-six (36) inches from the KPU underground conductors (including service conductors), pad mounted transformers, and power poles. They shall also be placed a minimum of thirty-six (36) inches from any propane or natural gas underground lines or service risers.
- 4.1.8 Where multiple rod-type grounding electrodes are used as part of the grounding electrode system, they shall be placed with a minimum of six (6) feet of separation.

4.2 Grounding Electrode Conductor

- 4.2.1 Grounding electrode conductor connecting the service entrance equipment to the grounding electrode system shall meet the following size requirements:
 - a) 100 Amp Services, #6 bare copper.
 - b) 200 through 400 Amp Services, #4 bare copper.
 - c) Services larger than 400 Amp, size the grounding electrode conductor in accordance with the requirements of **NEC 250.66 Size of Alternating-Current Grounding Electrode Conductor**.
- 4.2.2 The portion of the grounding electrode conductor interconnecting the grounding electrode systems (rod-type grounding electrodes, metal underground water pipe, structural steel, concrete-encased electrodes, etc.) shall be minimum #4 bare copper or as required by the NEC.

KPU ELECTRIC SERVICE REQUIREMENTS – RESIDENTIAL

4.2.3 Grounding electrode conductor shall be continuous and as defined in **NEC 250.64(C) Continuous**.

4.2.4 Grounding electrode conductor exposed to physical damage shall be protected in conduit.

4.3 Bonding and Grounding

4.3.1 Service entrance equipment shall be connected to the grounded electrode system, properly grounded, and bonded.

4.3.2 The grounding electrode systems and grounding electrode conductors shall be bonded in accordance with **NEC 250 Part III Grounding Electrode System and Grounding Conductor**.

4.3.3 Service entrance equipment shall be bonded in accordance with **NEC Article 250 Part V Bonding**.

4.3.4 When galvanized RMC is used, grounding bushings shall be installed and connected with a copper bonding or grounding wire.

4.3.5 Grounding conductors¹⁶ for interconnecting service entrance equipment and enclosures up to #2 AWG shall have a green jacket; otherwise they shall be marked green. Note: Grounding electrode conductor shall be bare copper.

4.3.6 The Grounding conductor shall be routed through all conduits interconnecting customer-owned service entrance equipment and enclosures in accordance with the requirements of the NEC.

4.3.7 CT service entrance equipment shall be grounded in accordance with **NEC Article 250 Part IX Instruments, Meters, and Relays**

¹⁶ Grounding conductors are not grounding electrode conductors; *Section 4.2 Grounding Electrode Conductor* requires that grounding electrode conductor be bare copper conductor.

KPU ELECTRIC SERVICE REQUIREMENTS – RESIDENTIAL

SECTION 5 – SERVICE ENTRANCE EQUIPMENT REQUIREMENTS

Customers shall provide and install the required service entrance equipment including customer-owned conduit and conductors, meter sockets, disconnects, enclosures, CT mounting bases, associated hardware, fittings, and bushings. KPU will furnish and install the required meter, CTs, CT test blocks, and CT wiring.

5.1 Self-Contained Meter Socket (Meter Panel) – 100 through 400 Amps

- 5.1.1 Meter panels shall be self-contained meter sockets with integrated breaker disconnect; the integrated breaker disconnect shall be lockable.
- 5.1.2 Meter panels **shall meet** Electric Utility Service Equipment Requirements Committee¹⁷ (EUSERC) requirements.
- 5.1.3 Meter panels **shall be** UL Listed and NEMA type 3R.
- 5.1.4 Meter panels **shall be** ring type; ringless sockets are **not approved**.
- 5.1.5 Meter panels above 225 Amps **shall have** test block bypasses; meter panels with automatic, horn-type, slider-type, or lever-type bypasses **shall not** be used and are **not approved**.
- 5.1.6 Meter panels shall be preconfigured for Form 2S (120/240V and 240/480V) and 12S (120/208V).
- 5.1.7 For more information please see the **Residential Combination Meter Panel (Fig. 19)** and **Meter Socket Connection Diagram (Fig. 20)**.

5.2 CT Service Entrance Equipment – 401 through 800 Amps

- 5.2.1 Services 401 through 800 Amps shall use a CT meter socket, CT enclosure, and service disconnect.
- 5.2.2 All conduit interconnecting the CT meter socket, CT enclosure, and service disconnect shall be galvanized RMC.
- 5.2.3 A main service disconnect shall be included between the CT enclosure and the customer load.
- 5.2.4 Meter sockets shall be ring type; ringless sockets **are not approved**.
- 5.2.5 Meter sockets **shall meet** EUSERC requirements.
- 5.2.6 Meter sockets and enclosures **shall be** UL Listed and NEMA type 3R.
- 5.2.7 All three-phase or network services **shall be** coordinated and approved by KPU.
- 5.2.8 For single-phase services, the CT rated meter socket shall be a wall mounted six (6) terminal (form 4S) meter socket or as otherwise directed by KPU; meter sockets shall accommodate a covered test switch, ten (10) Pole, with a dimension of nine and one-half (9 ½) inches and the panel cover for the test switch compartment shall be sealable or lockable.
- 5.2.9 Meter socket height requirements are in **Section 1 - General Service Requirements**.

¹⁷ <https://the.euserc.org/>

KPU ELECTRIC SERVICE REQUIREMENTS – RESIDENTIAL

- 5.2.10 For single-phase, the CT enclosure shall be wall mounted, minimum dimensions of thirty-six (36) inches wide by thirty-six (36) inches high by eleven (11) inches deep (36"Wx36"Hx11"D).
- 5.2.11 CT enclosures shall have a hinged front cover for access to the CTs and shall be lockable and sealable.
- 5.2.12 CT enclosures shall include CT mounting bases:
- a) Bases shall include provisions for two bar type CTs meeting the **requirements of ANSI C12.11 Instrument Transformers for Revenue Metering**, and one neutral bus bar.
 - b) Bases shall be insulated and rated 600 volts.
 - c) Bases shall be rated for the service; 600 Amps services shall use 800 Amps bases.
 - d) Bases shall have a 50,000 AIC rating.
- 5.2.13 The top of the CT enclosures shall have a maximum mounting height of eighty-four (84) inches above grade and minimum of sixty-four (64) inches above grade, the bottom of the CT enclosure shall be at least sixteen (16) inches above finish grade.
- 5.2.14 The finish grade **shall not be a deck or platform** unless otherwise approved by KPU.
- 5.2.15 The conduit connecting the CT enclosures to the meter socket shall meet the following:
- a) Have a direct run with no access points (e.g. LB Type Bodies).
 - b) Be twenty-five (25) feet or less in length.
 - c) The conduit shall be galvanized RMC unless otherwise approved by KPU.
 - d) Be one (1) inch minimum size.
 - e) Total bends limited to no more than three (3) quarter bends (270 degrees total) or less.

5.3 Main Service Disconnect

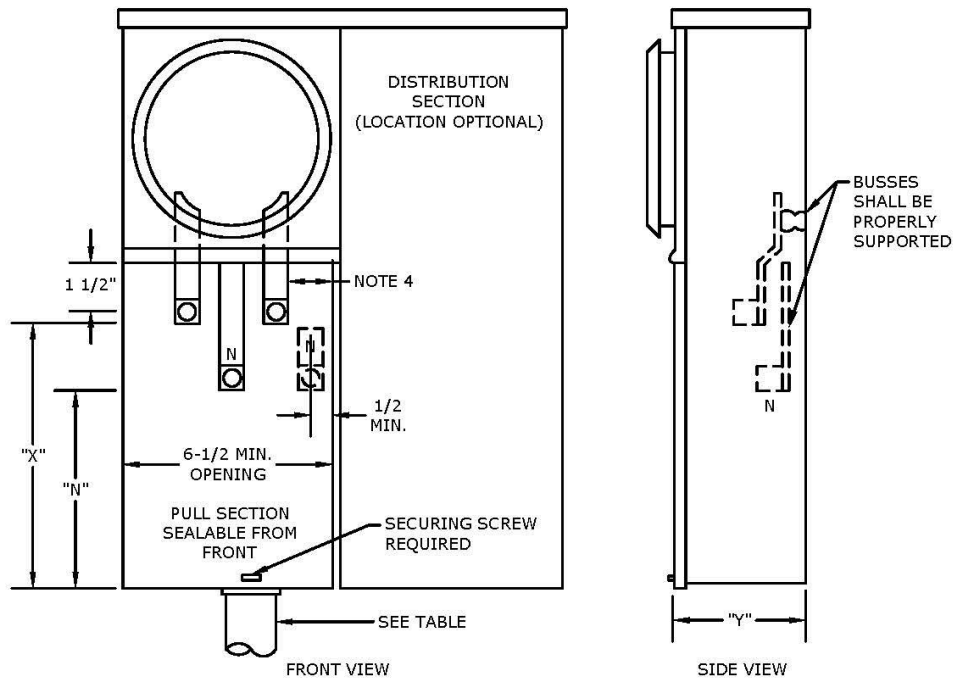
- 5.3.1 The service disconnect shall be rated for the service, UL Listed, and NEMA type 3R.
- 5.3.2 The service disconnect shall be lockable.

5.4 Wire Terminations and Connections

- 5.4.1 All wire terminations shall be coated with anti-oxidant for corrosion prevention.
- 5.4.2 Meter socket jaws shall be free of corrosion and damage.

RESIDENTIAL COMBINATION METER PANEL

FIG. 19
RESIDENTIAL COMBINATION METER PANEL 225 AMPERES
MAXIMUM 1-600 VOLTS



MAXIMUM AMPACITY	"X" MIN. DIM.	"N" MIN. DIM.	"Y" MIN. DIM.	CONDUIT RANGE
125	8"	6"	4"	1-1/4" TO 2-1/2"
225	11"	8-1/2"	5"	1-1/2" TO 3"

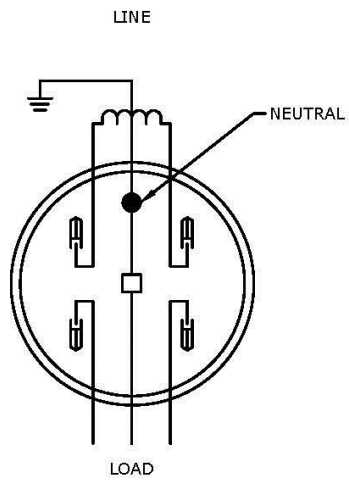
NOTES:

1. THIS EQUIPMENT MAY BE CONSTRUCTED FOR UNDERGROUND SERVICE SUPPLY OR AS A COMBINATION PANEL ALLOWING EITHER OVERHEAD OR UNDERGROUND SERVICE SUPPLY APPLICATIONS.
2. ONLY ONE SET OF TERMINATING FACILITIES SHALL BE PROVIDED AND LOCATED AS SHOWN FOR BOTH UNDERGROUND AND OVERHEAD SERVICE SUPPLY APPLICATIONS. THE TERMINATING FACILITIES FOR THE SERVICE CONDUCTORS SHALL BE ALUMINUM BODIED MECHANICAL LUGS WITH A RANGE OF NO. 6 THROUGH 1/0 AWG FOR THE 125 AMPERE DEVICE AND NO. 4 AWG THROUGH 250 KCMIL FOR THE 225 AMPERE DEVICE.
3. PROVIDE A BONDING SCREW OR JUMPER IF THE NEUTRAL TERMINAL IS INSULATED FROM THE ENCLOSURE.
4. A MINIMUM RADIAL CLEARANCE OF 1-1/2 INCHES SHALL BE PROVIDED BETWEEN THE HOT BUS TERMINALS, HOT BUS AND GROUND, AND HOT BUS AND NEUTRAL SURFACES.
EXCEPTION: THE CLEARANCE FROM THE HOT BUS TO THE BACK OF THE ENCLOSURE MAY BE REDUCED TO 1-INCH.

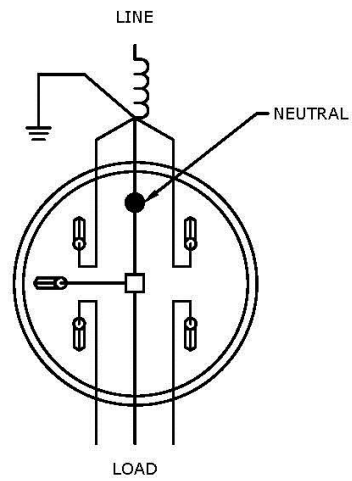
ALL DIMENSIONS SHOWN ARE IN INCHES

METER SOCKET CONNECTION DIAGRAM

FIG. 20
METER SOCKET CONNECTION DIAGRAM



120/240V AND 240/480V 3-WIRE



120/208V 3-WIRE NETWORK

KPU ELECTRIC SERVICE REQUIREMENTS – RESIDENTIAL

SECTION 6 – SPECIAL REQUIREMENTS

6.1 Multi-Meter Residential Services

In addition to the special requirements in this section, multi-meter residential services shall meet all of the requirements of the previous sections of this manual.

- 6.1.1 The customer shall furnish and install multiple metering service entrance equipment (multi-meter panels).
- 6.1.2 Multiple metering service entrance equipment **shall meet** EUSERC requirements
- 6.1.3 All multiple metering service entrance equipment **shall be** UL Listed and NEMA Type 3R.
- 6.1.4 Multi-meter panels shall have self-contained meter sockets appropriate for the type of service and number of meter points requested. Individual metering services shall be limited to 200 Amps or less serving each dwelling unit for residential multi-meter applications.
- 6.1.5 All self-contained meter sockets shall have an integrated breaker disconnect. The breaker disconnect shall control only the energy registered to the associated meter. The integrated main breaker shall be sealable.
- 6.1.6 Each meter socket position in a multi-meter installation **shall serve only one** dwelling unit or the common area; each dwelling unit or the common area shall be served by only one meter socket position.
- 6.1.7 Multi-meter panels with six (6) or fewer meter socket positions **shall not** have a main service disconnect on the source side (line-side, ahead of the meter sockets).
- 6.1.8 Multi-meter panels with seven (7) or more meter socket positions **shall have** a main service disconnect installed on the source side (line-side, ahead of the meter sockets).
- 6.1.9 KPU service entrance conductors **shall not** have terminations directly on the main service disconnect. Termination facilities comprised of an appropriately rated enclosure with termination facilities shall be provided and installed by the customer for entrance and termination of KPU service conductors.
- 6.1.10 Maximum ampacity rating for main disconnects and terminations shall be 1200 Amps; single-phase services shall have a maximum ampacity rating of 800 Amps. Services over 400 Amps shall be installed underground or as otherwise approved by KPU.
- 6.1.11 Meter socket height requirements are different from **Section 1 - General Service Requirements**. The meter sockets of multi-meter equipment shall have a maximum mounting height of seventy-five (75) inches and minimum mounting height of thirty-three (33) inches above finish grade.
- 6.1.12 The finish grade **shall not be a deck or platform** unless otherwise approved by KPU.
- 6.1.13 Each meter socket position and associated breaker disconnect shall be clearly and permanently labeled with the correct address and information.
- 6.1.14 All conduit interconnecting the service entrance equipment shall be galvanized RMC unless otherwise approved by KPU.

KPU ELECTRIC SERVICE REQUIREMENTS – RESIDENTIAL

- 6.1.15 Termination facilities for equipment rated 200 Amps and less may be aluminum bodied, mechanical lugs with a range from #4 AWG through 250 kcmil. Pull section shall have a minimum width of six and one-half (6 ½) inches for single phase, fourteen (14) inches for three-phase, and a minimum depth of five and one-half (5 ½) inches.
- 6.1.16 Termination facilities for equipment rated over 200 Amps shall consist of two (2) one-half (½) inch steel bolts per phase and neutral, in sets:
- a) 400 Amps or less, provide one (1) set of termination bolts.
 - b) 401 through 800 Amps, provide two (2) sets of termination bolts.
 - c) 801 through 1200 Amps, provide three (3) sets of termination bolts.
- 6.1.17 Pull sections for 400 Amp and less equipment shall have a minimum width of ten and one-half (10 ½) inches for single-phase, fourteen (14) inches for three-phase, and a minimum depth of six (6) inches.
- 6.1.18 Pull sections for 401-800 Amp equipment shall have a minimum width of sixteen and one-half (16 ½) inches for single-phase, twenty-two (22) inches for three-phase, and a minimum depth of six (6) inches.
- 6.1.19 Pull sections for 801-1200 Amp equipment shall have a minimum width of twenty-two and one-half (22 ½) inches for single-phase, thirty (30) inches for three-phase, and a minimum depth of six (6) inches.
- 6.1.20 Pull sections shall be independent of other service equipment and the covers shall be removable without disturbing adjacent panels. Covers shall be sealable, and provided with two lifting handles.

6.2 Primary Metered Residential Services

Primary metered residential services are not typical and must be coordinated with KPU to determine feasibility, design and installation requirements, and any additional customer cost.

COMBINATION RESIDENTIAL MULTI-METER PANELS

**FIG. 21
COMBINATION RESIDENTIAL
MULTI-METER PANELS, 6 METER MAX.**

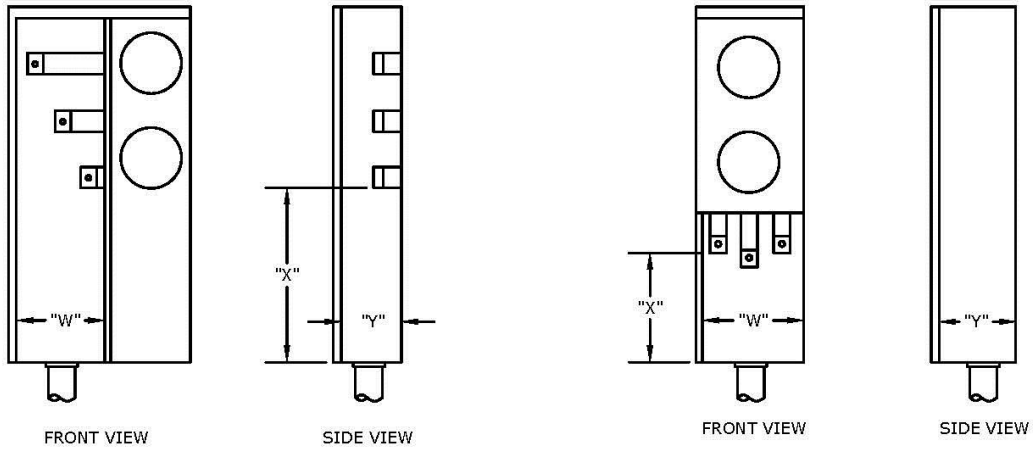


FIG. A FIG. B
TYPICAL SERVICE TERMINATING ARRANGEMENTS. TWO (2) METERS (0-200 AMPS)

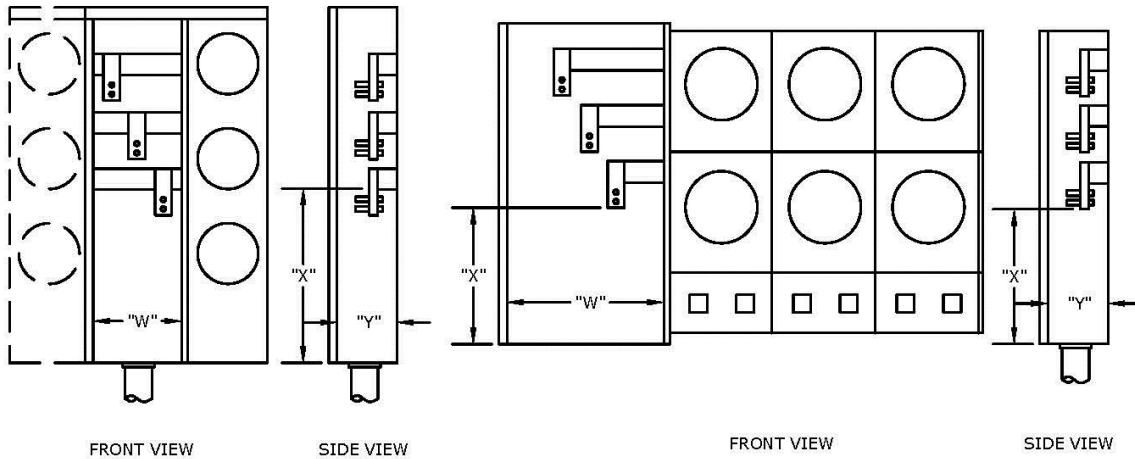


FIG. C FIG. D
TYPICAL SERVICE TERMINATING ARRANGEMENTS. 3 - 6 METERS (201-600 AMPS)

EQUIPMENT RATING	"W"	"Y"	"X"
0 - 200 AMPS	6-1/2 MIN.	5-1/2 MIN.	11 MIN.
201 - 600 AMPS	10-1/2 MIN.	6 MIN.	22 MIN.

ALL DIMENSIONS SHOWN ARE IN INCHES

WALL MOUNTED PULL BOX

**FIG. 22
WALL MOUNTED PULL BOX WITH
TERMINATING FACILITIES: 3-PHASE &
RESIDENTIAL W/ MORE THAN 6 METERS**

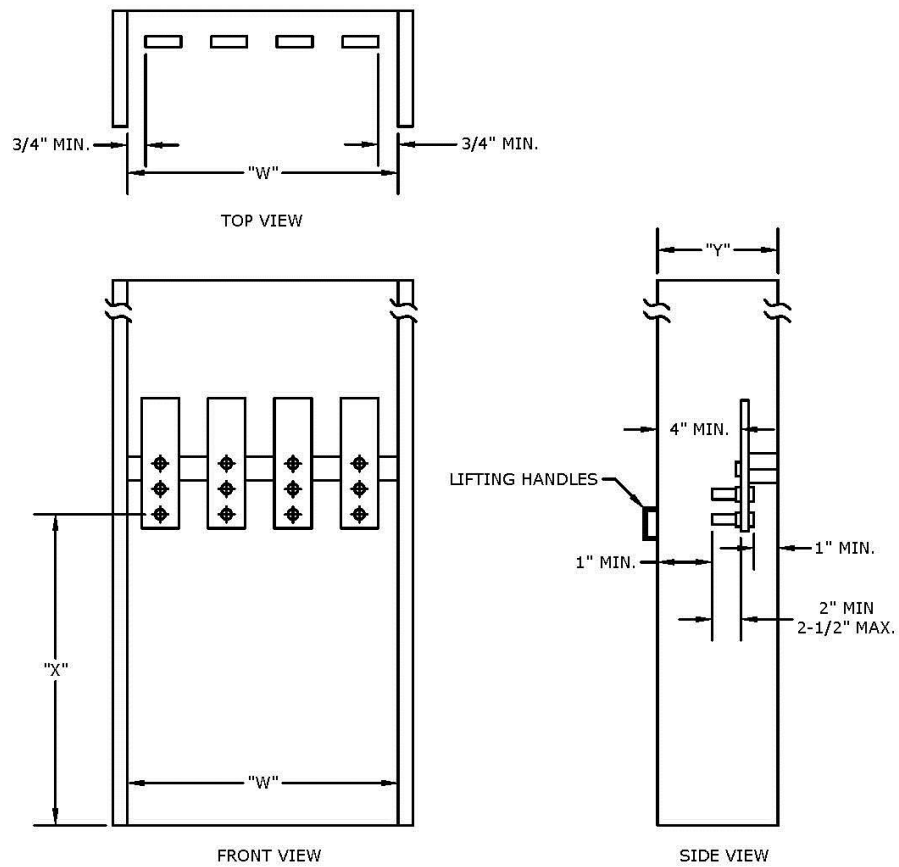


TABLE 1 (MINIMUM PULL BOX DIMENSIONS)

SERVICE AMPACITY	"W"		"Y"	"X"
	3 - WIRE	4 - WIRE		
0 - 200	N/A	14"	6"	11"
201 - 400	N/A	14"	6"	22"
401 - 800	16-1/2"	22"	11"	26"
801 - 1,200	22-1/2"	30"	11"	26"

KPU ELECTRIC SERVICE REQUIREMENTS – RESIDENTIAL

6.3 Standby Generators

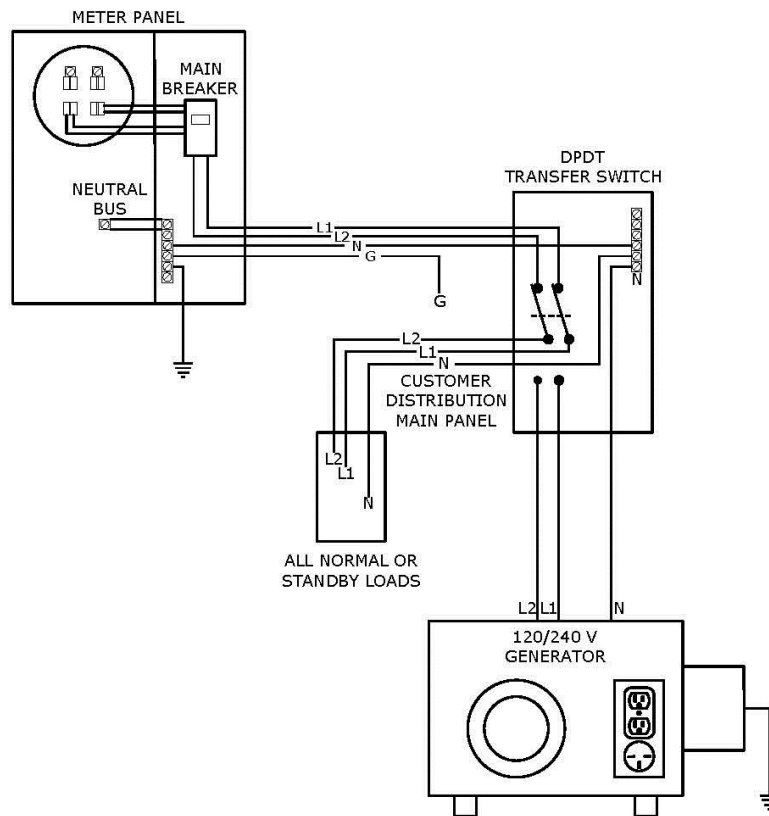
When incorporating a standby generator into your electrical system, proper installation is essential for safe operation. If not properly isolated, a standby generator can backfeed into the KPU electrical system, which can be very dangerous to personnel working to restore power during outages. For this reason, a double-pole double-throw transfer switch shall be installed to isolate the utility power. To assure proper application and compliance with NEC requirements, KPU recommends the switch be installed by a properly licensed contractor.

There are two types of approved installations; each alternative depends on the load requirements of the building or structure and generator load capacity.

- 6.3.1 **ALTERNATIVE 1** requires that the transfer switch be the same size as the main disconnect. This transfer switch arrangement is capable of carrying all loads under normal conditions, which means that the only limiting factor on electrical capability during outage conditions is the size of the standby generator. Under outage conditions, you may need to turn off circuits except those that feed selected loads unless the generator is large enough to carry the entire load. For more details, see *Standby Generator, Alternative 1 (Fig. 23)*.
- 6.3.2 **ALTERNATIVE 2** allows selected loads to be separated from the main distribution panel and wired into a sub panel. The generator will supply power to these loads only. The limitation of this alternative is that the entire house load cannot be incorporated into the standby generator circuit. For more details, see *Standby Generator, Alternative 2 (Fig. 24)*.

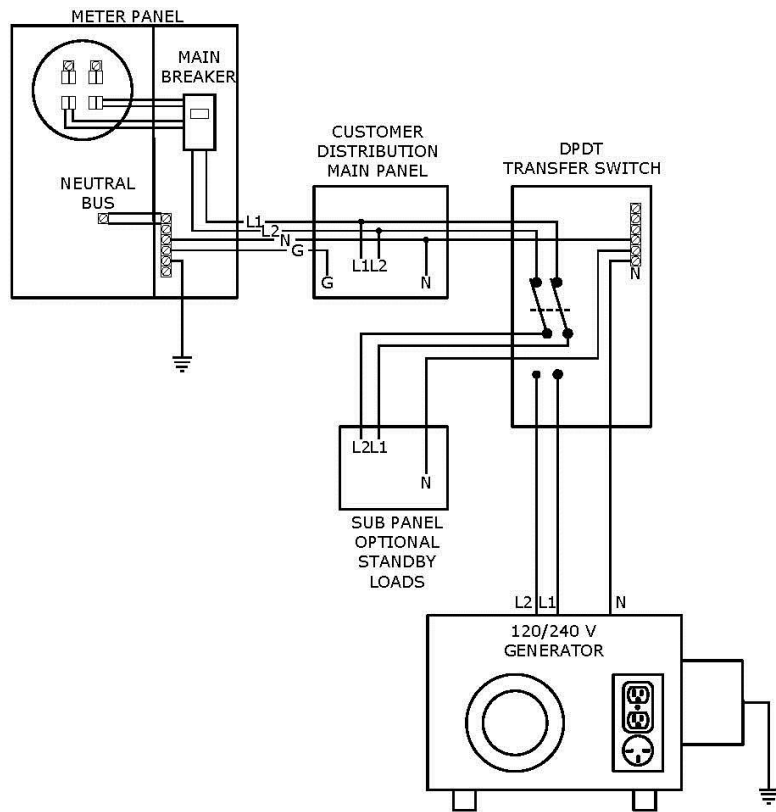
STANDBY GENERATOR

FIG. 23
STANDBY GENERATOR, ALTERNATIVE 1
GENERATOR SUPPLIES ALL LOADS



STANDBY GENERATOR

FIG. 24
STANDBY GENERATOR, ALTERNATIVE 2
GENERATOR SUPPLIES SELECTED LOADS ONLY



KPU ELECTRIC SERVICE REQUIREMENTS – RESIDENTIAL

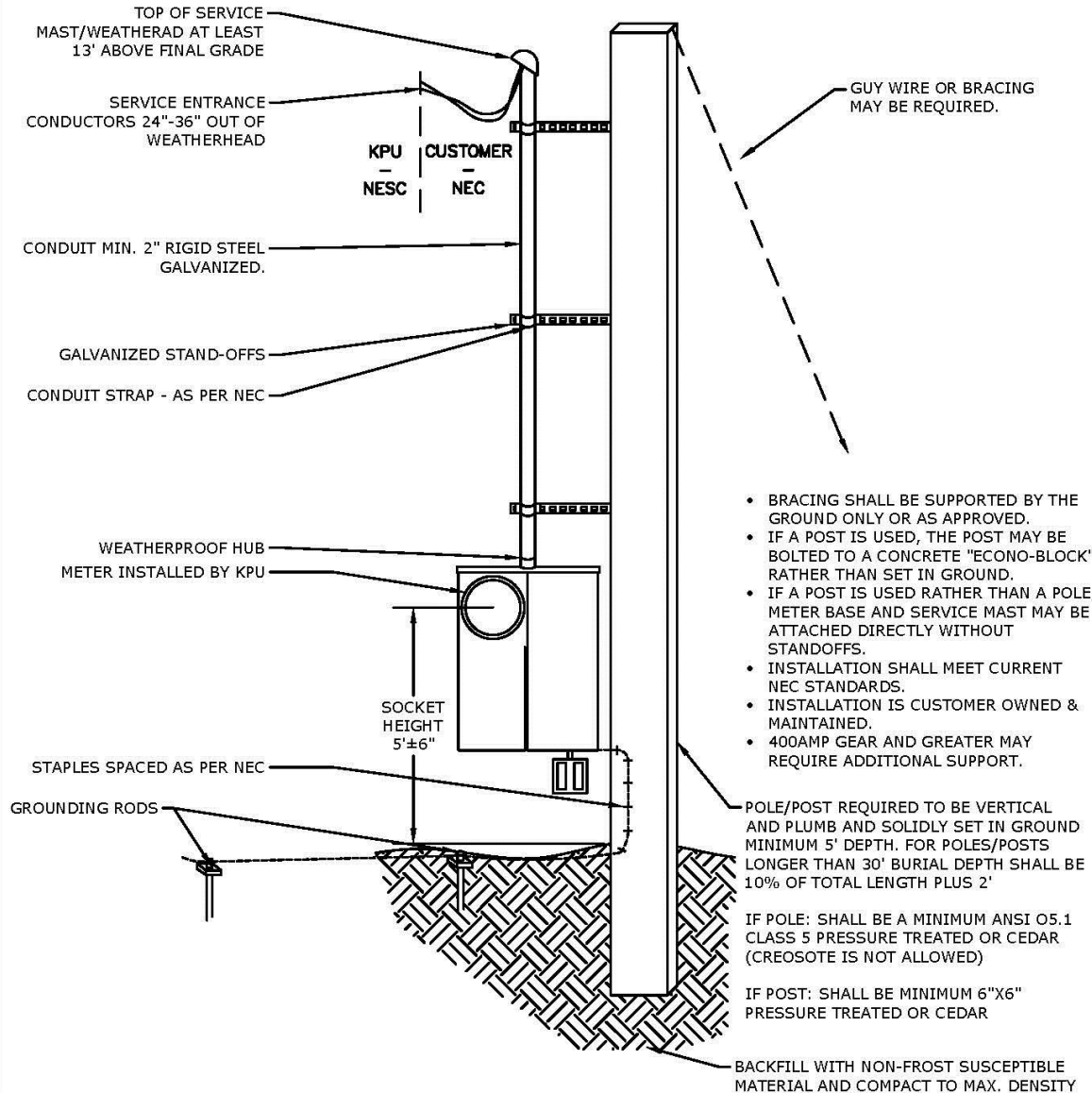
6.4 Temporary Services

Where desired by the customer, KPU will extend temporary electric service to customer service entrance equipment at locations as approved by KPU. The customer may be responsible for payment of installation and removal costs for temporary services. If required, payment shall be made prior to service construction.

- 6.4.1 Temporary services shall be installed underground where existing KPU facilities are underground; where KPU facilities are overhead, the customer may receive either overhead or underground temporary service as approved by KPU.
- 6.4.2 Depending on the timing of when an underground service is installed, it may be necessary to temporarily install it aboveground in Corflo® duct or electrical non-metallic conduit. KPU will not install Corflo® or non-metallic conduit aboveground across roadways, driveways, or other locations subject to traffic or potential damage.
- 6.4.3 The service type being requested shall be for the service entrance equipment designed to accept that service (e.g. underground to underground service entrance equipment and overhead to overhead service entrance equipment).
- 6.4.4 Temporary services shall meet the requirements of all sections of this manual.
- 6.4.5 Any temporary service configuration other than that shown must be approved by KPU; for more information, see ***Meter Pole/Post Specification – Overhead Temporary/Construction (Fig. 25)***.

METER POLE/POST SPECIFICATIONS - OVERHEAD TEMPORARY/CONSTRUCTION POWER

**FIG. 25
OVERHEAD TEMPORARY CONSTRUCTION SERVICE**



GROUNDING & BONDING

THE METER PANEL MUST HAVE EITHER:

- TWO GROUND RODS THAT ARE VISIBLY CONNECTED AND PROPERLY DRIVEN WITH 6 FEET BETWEEN THEM, OR;
- ONE GROUND ROD THAT IS VISIBLY CONNECTED AND PROPERLY DRIVEN AND A COPPER GROUND ELECTRODE CONDUCTOR CONNECTED EITHER TO THE BUILDING'S WATER PIPING OR TO A CONCRETE ENCASED "UFER" GROUND.

100 AMP SERVICES - CONNECT WITH #6 COPPER GROUNDING ELECTRODE CONDUCTOR.

200 AMP SERVICES - CONNECT WITH #4 COPPER GROUNDING ELECTRODE CONDUCTOR.

400 AMP SERVICES - CONNECT WITH #4 COPPER GROUNDING ELECTRODE CONDUCTOR.

KPU ELECTRIC SERVICE REQUIREMENTS – RESIDENTIAL

APPENDIX A – Forms and Checklist

PAGE INTENTIONALLY LEFT BLANK

KPU ELECTRICAL SERVICE REQUEST – RESIDENTIAL

Customer Information

Name: _____

Address or Location of Service: _____

Mailing Address: _____

Email Address: _____ Phone Number: _____

Contractor Information

Contractor Name: _____

Point of Contact: _____ Phone Number: _____

Type of Request

New Service ---- Will this be your new permanent personal residence? Yes No

Relocation Upgrade Overhead/Underground Conversion

Will temporary construction power be needed?

Yes No

Service Information

Overhead Underground Combination Overhead/Underground

Service Size:

100 Amp 200 Amp 400 Amp Other: _____

Meter Base Mounting:

Building Meter Pole/Post Pedestal

Will there be a back-up generator installed? Yes No

Estimated date service is required to be complete: ____ / ____ / 20____

Property Information

Survey Number: _____ Block: _____ Lot: _____

Plat Number: _____

Are property corners surveyed and marked? Yes No

For property information, contact the Ketchikan Gateway Borough Planning and Community Development at (907) 228-6610.

Other Information and Notes

Signature: _____ Date: ____ / ____ / 20____

After this form is complete, please submit to the KPU Electric front office.

1065 Fair Street Ketchikan, AK 99901

For more information or questions, please call (907) 225-5505

PAGE INTENTIONALLY LEFT BLANK

Ketchikan Public Utilities Residential Service Checklist

- Contact KPU Electric for electric service information, (907) 225-5505.
- Complete and submit the ***Electrical Service Request - Residential*** form.
- Schedule onsite visit with KPU personnel, (907) 225-5505.
- Complete onsite visit with KPU personnel.
- Have a KPU approved service route and entrance location.
- If a utility easement agreement is required, it must be recorded before KPU will begin construction on KPU-owned infrastructure and equipment.
- Obtain Zoning Permits from Ketchikan Gateway Borough Planning and Community Development Department, (907) 228-6610.
- Within City Limits**, obtain Building Permits from the City Building Officials at the City of Ketchikan Public Works Department, (907) 228-4727.
- Setup a new electric service account with KPU Customer Service, (907) 228-5474.
- Complete construction of electrical service equipment; service is ready for inspection.
- Within City Limits**, obtain an inspection from City Building Officials for a *Blue Tag*, (907) 228-4727.
- Outside City Limits**, obtain an inspection from KPU Electric to verify the electric service is ready for connection, (907) 225-5505.
- After an approved inspection, contact KPU Electric when ready for connection and meter installation, (907) 225-5505.